

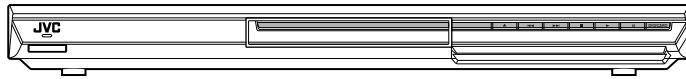

DVD PLAYER/MEMORY CARD READER

XV-NP10S



AV COMPU LINK *Digital Direct Progressive Scan*



Region code of DVD VIDEO

This player can play back DVD VIDEO discs whose region code whose Region Code numbers include the player's Region Code, which is indicated on the region code symbol on the rear panel.

Examples of playable DVD VIDEO discs:



The player's region code is printed on the rear of the player.

Before operation 2

Preparations 5

Basic operations 10

Advanced operations 15

Audio/Video files playback 23

Changing the initial settings 28

Additional information 33

INSTRUCTIONS

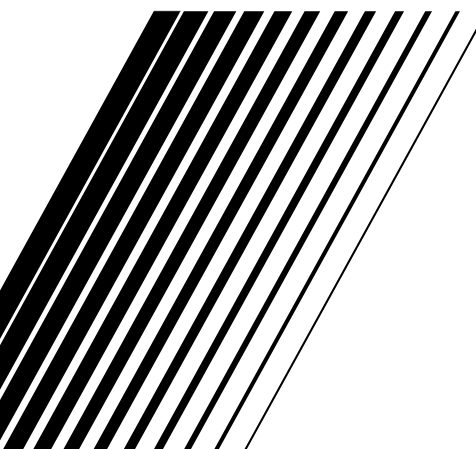

Warnings, Cautions and Others

CAUTION

To reduce the risk of electrical shocks, fire, etc.:

1. Do not remove screws, covers or cabinet.
2. Do not expose this appliance to rain or moisture.

Caution — STANDBY/ON button!

Disconnect the mains plug to shut the power off completely (the STANDBY/ON lamp goes off). The STANDBY/ON  button in any position does not disconnect the mains line.

- When the player is on standby, the STANDBY/ON lamp lights red.
- When the player is turned on, the STANDBY/ON lamp lights green. The power can be remote controlled.

CAUTION:

- Do not block the ventilation openings or holes.
(If the ventilation openings or holes are blocked by a newspaper or cloth, etc., the heat may not be able to get out.)
- Do not place any naked flame sources, such as lighted candles, on the apparatus.
- When discarding batteries, environmental problems must be considered and local rules or laws governing the disposal of these batteries must be followed strictly.
- Do not expose this apparatus to rain, moisture, dripping or splashing and that no objects filled with liquids, such as vases, shall be placed on the apparatus.

Caution: Proper Ventilation

To avoid risk of electric shock and fire and to protect from damage, locate the apparatus as follows:

Front: No obstructions and open spacing.

Sides: No obstructions in 3 cm from the sides.

Top: No obstructions in 5 cm from the top.

Back: No obstructions in 15 cm from the back

Bottom: No obstructions, place on the level surface.

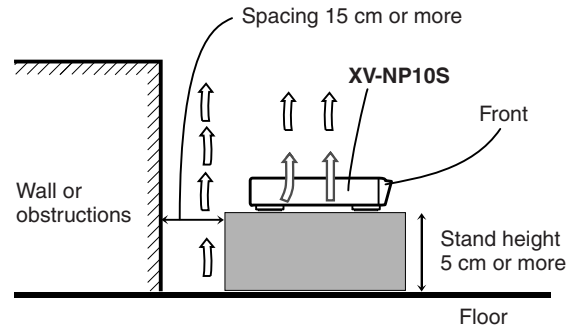

IMPORTANT FOR LASER PRODUCTS

1. CLASS 1 LASER PRODUCT

2. **CAUTION:** Do not open the top cover. There are no user serviceable parts inside the unit; leave all servicing to qualified service personnel.

3. **CAUTION:** Visible and invisible laser radiation when open and interlock failed or defeated. Avoid direct exposure to beam.

4. REPRODUCTION OF LABEL: CAUTION LABEL, PLACED INSIDE THE UNIT.

<p>CAUTION: Visible and invisible laser radiation when open and interlock failed or defeated. AVOID DIRECT EXPOSURE TO BEAM.</p> <p>(e)</p>	<p>ADVARSEL: Synlig og usynlig laserstråling når maskinen er åben eller interlocken fejler. Undgå direkte eksponering til stråling.</p> <p>(d)</p>	<p>VARNING: Synlig och osynlig laserstråling när den öppnas och spärren är urkopplad. Beträkta ej strålen.</p> <p>(s)</p>	<p>VARO: Avattaessa ja suojalukitus ohitettuna tai viallisena olet alttiina näkyvälle ja näkymättömälle lasersäteilylle. Vältä säteen kohdistumista suoraan itseesi.</p> <p>(f)</p>
--	---	--	--

Supplied accessories

Check that you have all the following accessories supplied to you. If anything is missing, consult your dealer immediately.

- Audio/video cable (Yellow/White/Red) (× 1)
- Remote control unit (× 1)
- R6P(SUM-3)/AA(15F) battery (× 2)
- AC power plug adaptor (× 1)
(except for Australia and Hongkong models)

About this manual

- The display window information and OSD (On Screen Display) menu items are put in brackets [] in the operation procedures.
- Usable disc(s) for each operation/function is (are) referred to by the icons;



Precautions

Notes on the power cord

- When you are away on travel or otherwise for an extended period of time, remove the plug from the wall outlet. A small amount of power (1.1 W) is always consumed while the power cord is connected to the wall outlet.
- When unplugging the player from the wall outlet, always pull the plug, not the power cord.
- Do not handle the power cord with wet hands!

Avoid moisture, water and dust

- Do not place the player in moist or dusty places.
- If water gets inside the player, turn off the power and remove the plug from the wall outlet, then consult your dealer. Using the player in this state may cause a fire or electrical shock.

Avoid high temperatures

- Do not expose the player to direct sunlight or place it near a heating device.

Notes on installation

- Select a place which is level, dry and neither too hot nor too cold between 5° C and 35° C.
- Leave sufficient distance between the player and the TV.
- Do not install the player in a place subject to vibrations.
- Do not put heavy objects on the player.

To prevent malfunction of the player

- There are no user-serviceable parts inside. If anything goes wrong, unplug the power cord and consult your dealer.
- Do not insert any metallic objects, such as wires, hairpins, coins, etc. into the player.
- Do not block the vents. Blocking the vents may damage the player.

To clean the cabinet

- Use a soft cloth. Follow the relevant instructions on the use of chemically-coated cloths.
- Do not use benzene, thinner or other organic solvents and disinfectants. These may cause deformation or discoloring.

Table of contents





Before operation	2
About playable media	2
Care and handling of discs	2
Names of parts and controls.....	3
Preparations	5
Connections.....	5
Using the remote control unit.....	8
Basic operations	10
Turning on/off the player.....	10
Initial setup	10
Basic playback.....	11
Resuming playback	12
Various speed playback	13
Locating the beginning of a scene or song.....	14
Advanced operations	15
Playing from a specific position	15
Changing the playback order.....	17
Repeat playback.....	18
Changing the language, sound and scene angle	19
Special picture/sound effect	20
Menu bar functions	21
Audio/Video files playback	23
Outline	23
Basic operations	24
Direct selection for JPEG files	25
Repeat playback.....	25
Slide show playback	26
Changing the picture of the opening display	26
BGM slide show playback	27
Changing the initial settings	28
Selecting preferences	28
Limiting playback by children.....	31
Additional information	33
AV COMPU LINK remote control system	33
Troubleshooting	34
Specifications	35
Appendix A: Digital output signal chart.....	35
Appendix B: Country/Area code list for Parental Lock.....	36
Appendix C: Table of languages and their abbreviations	36
Appendix D: Glossary	37

Before operation

About playable media

Playable disc types

Discs with the following marks can be played back on the player.

DVD VIDEO 	SVCD 	Video CD 	Audio CD 
--	---	---	---

The DVD Logo is a trademark.

The player can also play back the following discs:

- The finalized DVD-R and DVD-RW discs written in the DVD VIDEO format.
- The DivX file on the DVD-R and DVD-RW discs written in the UDF format.
- The finalized CD-R and CD-RW discs written in the SVCD, Video CD or Audio CD format.
- CD-R and CD-RW discs written in MP3/WMA/JPEG/MPEG-4/DivX in accordance with the "ISO 9660" format. (For details, see page 23.)

NOTE

If a disc gets dirty, scratched or warped, or due to the disc characteristics or recording conditions, it may take considerable time for the player to read the content, or the player may not be able to play back such discs.

The player can also play back audio signals recorded in MIX-MODE CD, CD-G, CD-EXTRA and CD TEXT.

Color system format

This player is compatible with the PAL and NTSC systems. You can select "PAL" or "NTSC" while using the PAL/NTSC selector on the rear panel.

Note that the PAL video signal on a disc is converted to an NTSC signal and output. With some discs, the playback picture may become jagged.

Digital audio formats

The player supports the following digital audio formats (see page 37 "Glossary" for descriptions of each audio format):

Linear PCM, Dolby Digital, DTS (Digital Theater Systems)

NOTE

Depending on the player's [DIGITAL AUDIO OUTPUT] setting, digital audio signals may not be output as they are recorded on the disc. See "DIGITAL AUDIO OUTPUT" on page 30 for details.

Notes on discs

- With some DVD VIDEO discs, the player starts playback automatically after inserting the disc.
- The image may be sometimes poor or noisy due to defects in the disc itself.
- With some discs, operations described in this manual may not be possible.

Unplayable discs

The player does not play back discs listed below.

- DVD-RW discs written in the VR format
- DVD-ROM, DVD-RAM, DVD AUDIO, CD-ROM, PHOTO CD, SACD

In addition, the player does not play:

- Unfinalized discs.
- Discs of irregular shape or discs with tape, seals or paste on either the label side or playback side. Playing back these discs may damage the player.

Playable memory cards

This player has two types of the exclusive insertion slot for the memory cards; one is the 5 in 1 slot for SD card (SD), MultiMediaCard (MMC), SmartMedia (SM), Memory Stick (MS), and xD-Picture Card (xD), the other for CompactFlash (CF).

You can play back the following files written in memory cards:

- MP3, WMA, JPEG, MPEG-4 (Simple profile)

Requirements for memory cards

- Format: Fat 12/16
- Voltage type: 3.3 V
- Storage type: Up to 128 MB (256 MB type is also available for only SD, xD, and CF). 4 MB type is not available for MMC and xD.
- For CompactFlash: Type I
- Protection: Secure MMC card and Magic Gate Memory Stick are not available.
- For Memory Stick: Memory Stick Pro and Memory Stick Duo are not available.

NOTES

- The playback order may differ from that of the other device such as a digital still/video camera.
- The memory cards initialized by PC are not available.
- The player may be unable to play back some CompactFlash which are available for the high speed reading/writing.
- The player may be unable to play back some memory cards due to their characteristics or recording conditions.
- Memory cards are precision instruments. DO NOT impact, bend, drop, or wet them.

SD, Secure SD, MultiMediaCard, SmartMedia, CompactFlash, Memory Stick, xD-Picture Card are trademarks of their respective product companies.

Notes on copyright

Check the copyright laws in your country before recording from DVD VIDEO, SVCD, Video CD, Audio CD, MP3, WMA, JPEG, MPEG-4, and DivX discs.

Recording of copyrighted material may infringe copyright laws.

Care and handling of discs

If a disc gets dirty, dusty, scratched or warped, playback sound and picture may be deteriorated. Take proper precautions when handling discs.

Handling

- Do not touch the surface of the disc.
- Do not damage, stick paper to, or use any adhesive on either the label side or playback side.

Storing discs

- Keep discs in their cases. If discs are piled on top of one another without their protective cases, they can be damaged.
- Do not put discs in a location where they may be exposed to direct sunlight, or where the humidity or temperature is high. Avoid leaving discs in a car!

Cleaning discs

- Wipe with a soft dry cloth, moving from the center outwards. If a disc is difficult to clean, wipe with a cloth moistened with water.
- Never use record cleaners, petrol, alcohol or any anti-static agents.

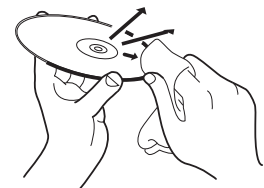

Names of parts and controls

Front panel

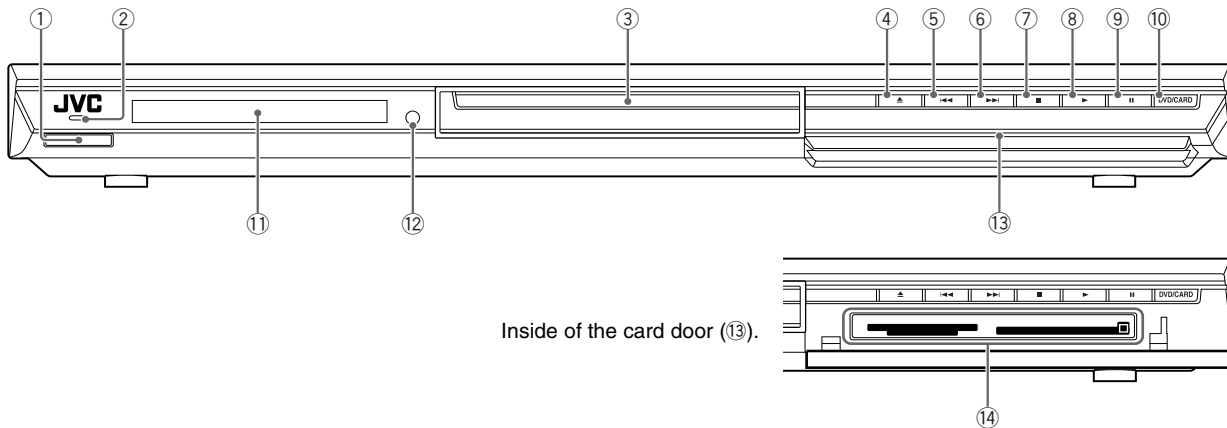

- ① ⏻ button (10)
- ② STANDBY/ON indicator (10)
- ③ Disc tray (11)
- ④ ▲ (eject) button (11)
- ⑤ ◀◀ button (13, 14)
- ⑥ ▶▶ button (13, 14)
- ⑦ ■ (stop) button (12, 13, 15)
- ⑧ ▶ (play) button (11, 13)
- ⑨ || (pause) button (12, 13, 25)
- ⑩ DVD/CARD button (13, 24, 27)
- ⑪ Display window (see below)
- ⑫ Remote sensor (8)
- ⑬ Card door (24)
- ⑭ Memory card slots (24)

How to open/close the card door

- Make sure the disc playback is stopped when inserting or removing the memory card.



Display window

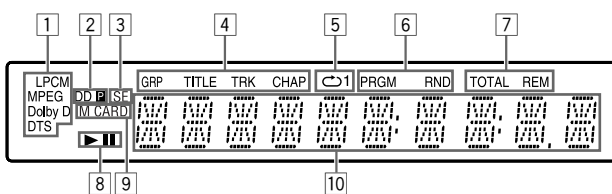

- ① **Audio format indicators**
[LPCM] Turns on when linear PCM audio signals are output from the player, for example when playing back an Audio CD disc.
[MPEG] Turns on when MPEG signals are output from the player, for example when playing back a Video CD disc.
[Dolby D] Turns on when playing back a Dolby Digital sound source.
[DTS] Turns on when playing back a DTS-encoded digital sound source.
- ② **Progressive indicators**
[P] Turns on while in the Progressive scanning mode.
[DDP] Turns on depending on the [PICTURE SOURCE] preference setting and the source type of the current DVD VIDEO disc (see page 6).
- ③ **SE (Sound Effect) indicator**
Turns on when the Sound Effect function takes effect.
- ④ **Group/title/track/chapter indicators**
Show what is indicated by the multi-information display during playback.
- ⑤ **Repeat mode indicator**
Turns on while in the repeat mode and shows the currently selected repeat mode.
- ⑥ **Program/random indicators**
Turn on while in the program playback mode or random playback mode respectively.
- ⑦ **Total time/remaining time indicators**
[TOTAL] Turns on when total elapsed time is indicated by the multi-information display.
[REM] Turns on when remaining playback time is indicated by the multi-information display.
- ⑧ **▶(play) / ||(pause) indicators**
Turn on while in playback or in pause respectively.
- ⑨ **M (memory) CARD indicator**
Turns on while accessing a memory card.
- ⑩ **Multi-information window**
Indicates various kinds of information by numbers and alphabets, such as the player's current status ("READING," "OPEN," etc.) or currently played DVD's title and chapter.

Remote control unit

Before operation

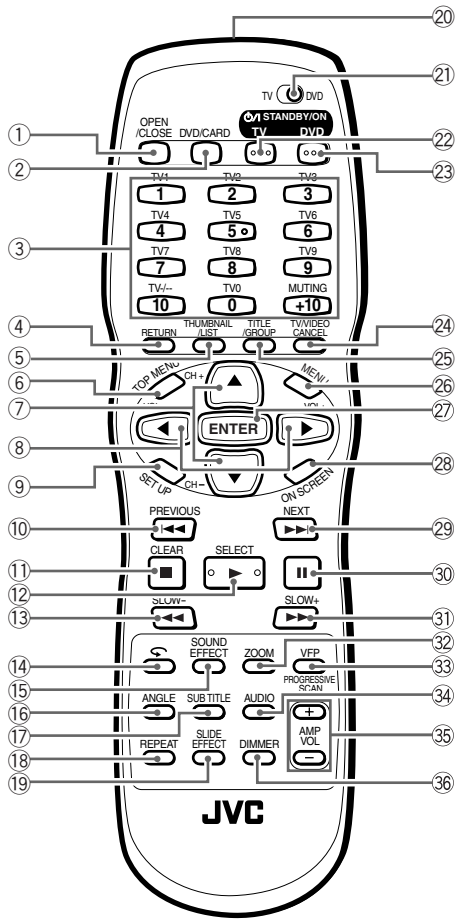

- ① OPEN/CLOSE button (11)
- ② DVD/CARD button (13, 24, 27)
- ③ Numeric buttons
- ④ RETURN button (15)
- ⑤ THUMBNAIL/LIST button (25)
- ⑥ TOP MENU button (15)
- ⑦ Cursor selection (▲ Up, ▼ Down) - CH (+/-) buttons
- ⑧ Cursor selection (◀ Left, ▶ Right) - VOL (+/-) buttons
- ⑨ SET UP button (11, 26, 28)
- ⑩ ◀◀/PREVIOUS button (13, 14, 15, 17, 25, 27)
- ⑪ ■/CLEAR button (12, 17, 18, 25, 26)
- ⑫ ▶/SELECT button (11, 13, 15, 17, 26)
- ⑬ ◀◀/SLOW- button (13, 25)
- ⑭ ↻ button (14)
- ⑮ SOUND EFFECT button (21)
- ⑯ ANGLE button (19)
- ⑰ SUBTITLE button (19)
- ⑱ REPEAT button (18, 25, 27)
- ⑲ SLIDE EFFECT button (26)
- ⑳ Infrared signal window (8)
- ㉑ TV - DVD switch (9, 10, 15, 24, 26, 28)
- ㉒ TV ⏻/ STANDBY/ON button (9)
- ㉓ DVD ⏻/ STANDBY/ON button (10)
- ㉔ TV/VIDEO - CANCEL button (9, 17)
- ㉕ TITLE/GROUP button (15)
- ㉖ MENU button (15)
- ㉗ ENTER button
- ㉘ ON SCREEN button (12, 16, 18, 21)
- ㉙ ▶▶/NEXT button (13, 14, 15, 17, 25, 27)
- ㉚ || button (12, 13, 26)
- ㉛ ▶▶/SLOW+ button (13, 25)
- ㉜ ZOOM button (20, 25)
- ㉝ VFP - PROGRESSIVE SCAN button (6, 20)
- ㉞ AUDIO button (19)
- ㉟ AMP VOL +/- buttons (9)
- ㊱ DIMMER button (See below)

To change the brightness of the display window

Press DIMMER on the remote control unit.

You can select the brightness of the display window and the illumination on the front panel from three levels, or off.

If the brightness is set to off, nothing will be shown on the display. In this case, the illumination on the front panel is also turned off.

Preparations

Connections

Before using the player, connect the player to a TV and/or amplifier.

Before making connections

- Do not connect the AC power cord until all other connections have been made.
- Connect VIDEO OUT of the player directly to the video input of your TV. Connecting VIDEO OUT of the player to a TV via a VCR may cause a monitor problem when playing back a copy-protected disc. You may also have a monitor problem when connecting the player to an integrated TV/Video system.

NOTE

If your TV has an AV COMPU LINK terminal, you can use the AV COMPU LINK function. See "AV COMPU LINK remote control system" on page 33 for details.

- In the following description, "TV" may be substituted with "monitor" or "projector."
- Terminal names used for other components may be different from those used in the following description.

Connecting to a TV

The following sections A to C describe TV connections where only a TV is connected to the player so that you will hear sound from the TV.

A Connecting to a conventional TV

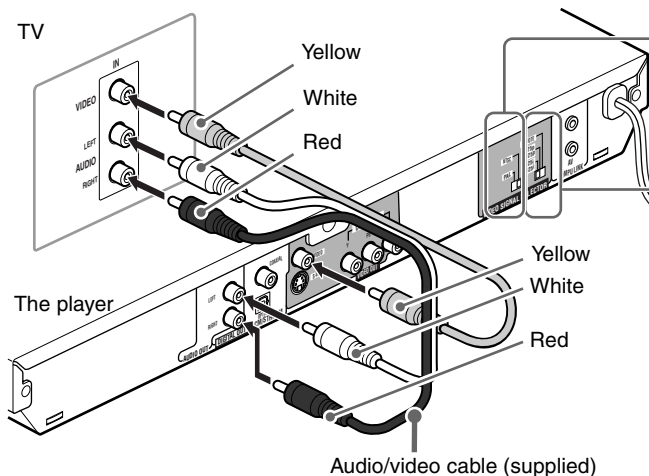

NOTES

- Do not connect an S-video cable to the S-VIDEO output of the player. If you do so, you will not be able to obtain correct signals from the VIDEO jack of the player.
- If your TV has a monaural audio input instead of stereo, you need to use an optional audio cable which converts stereo audio output to monaural.
- You must change the VIDEO SIGNAL SELECTOR position while the player power is off. Otherwise, the changed setting is not effective.

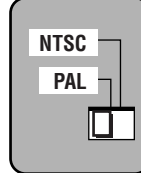

Set the PAL/NTSC selector to "PAL" or "NTSC" to match the color system of your TV. (Change the selector position in stop mode or with no disc inserted.)

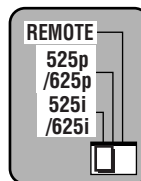

Set the 525i/625i - 525p/625p - REMOTE selector to "525i/625i."

B Connecting to a TV with an S-video jack

If your TV has an S-VIDEO input, you can get better picture quality by connecting it with the S-VIDEO output of the player using an S-video cable instead of connecting the video input of the TV to the VIDEO jack of the player.

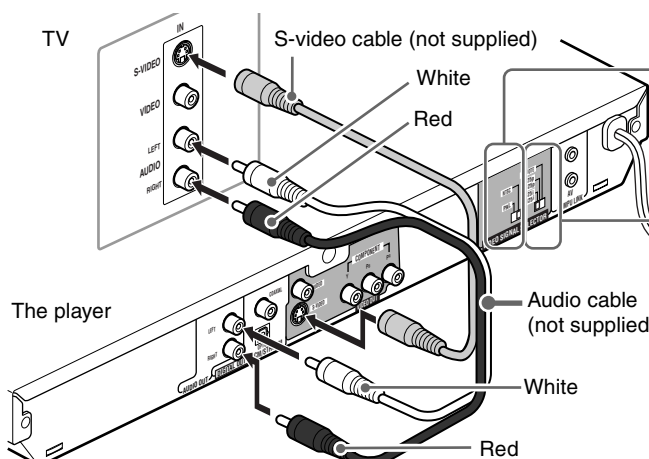

NOTES

- To obtain correct signals from the S-VIDEO output, do not connect cables to the VIDEO jack and COMPONENT VIDEO OUT jacks of the player.
- You must change the VIDEO SIGNAL SELECTOR position while the player power is off. Otherwise, the changed setting is not effective.

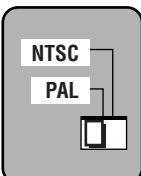

Set the PAL/NTSC selector to "PAL" or "NTSC" to match the color system of your TV. (Change the selector position in stop mode or with no disc inserted.)

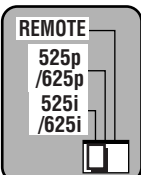

Set the 525i/625i - 525p/625p - REMOTE selector to "525i/625i."

Preparations

© Connecting to a TV with component jacks.

You can enjoy picture of high-fidelity color reproduction by connecting the COMPONENT VIDEO OUT jacks on the player to your TV.

NOTES

- Connect "Y" to "Y," "P_B" to "P_B" (C_B), "P_R" to "P_R" (C_R) correctly.
- When using the COMPONENT VIDEO OUT jacks, do not connect the S-VIDEO output jack on the player.
- If your TV has component video input jacks of BNC type, use an adapter which converts a pin jack to a BNC jack (not supplied).

Progressive scan video playback available

In the Progressive scanning mode, you can enjoy high quality picture with less flickers when the COMPONENT VIDEO OUT jacks are connected to a TV or monitor that supports the progressive video input.

HINT

Depending on the material source format, DVD VIDEO discs can be classified into two types; film source and video source (note that some DVD VIDEO discs contain both film source and video source). Film sources are recorded as 24-frame-per-second information, while (NTSC) video sources are recorded as 30-frame-per-second (60-field-per-second interlaced) information. When the player plays back a film source material, Progressive (uninterlaced) output signals are created using the original information. When a video source material is played back, the player interleaves lines between the interlaced lines on each to create the interpolated picture and outputs as the progressive signal.

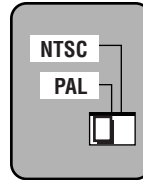
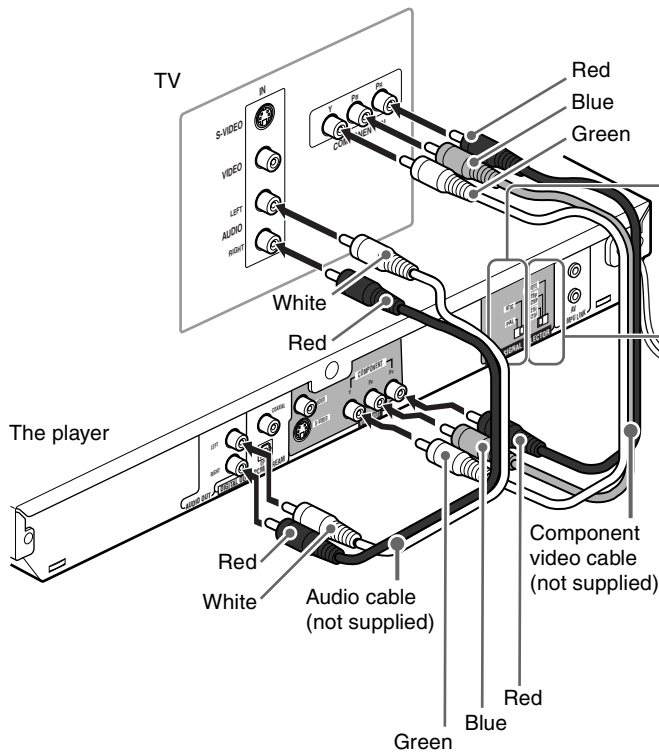

Set the PAL/NTSC selector to "PAL" or "NTSC" to match the color system of your TV. (Change the selector position in stop mode or with no disc inserted.)

Selecting the 525i/625i - 525p/625p - REMOTE selector position

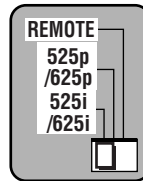

If your TV equipped with component jacks does not support the progressive scanning mode:
Set the 525i/625i - 525p/625p - REMOTE selector to "525i/ 625i."

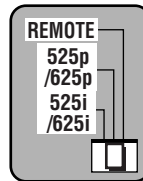

If your TV equipped with component jacks supports the progressive scanning mode:
Set the 525i/625i - 525p/ 625p - REMOTE selector to "525p/ 625p."

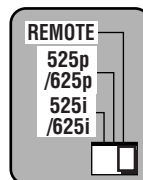

If you want to select the scanning mode between the interlace and progressive modes (depending on the source condition, or when connecting more than one TV, etc.):
Set the 525i/625i - 525p/625p - REMOTE selector to "REMOTE."
Thus you can select the mode from the remote control unit.

NOTE

You must change the VIDEO SIGNAL SELECTOR position while the player power is off. Otherwise, the changed setting is not effective.

Activating the Progressive scanning mode using the remote control unit

When the player is turned on and the 525i/625i - 525p/625p - REMOTE is set to "REMOTE," press and hold down VFP - PROGRESSIVE SCAN for a few seconds.

The scanning mode switches between the Progressive scanning and Interlaced scanning modes.

When the scanning mode is set to the Progressive mode, the [P] indicator lights up in the display window. [DD] indicator also lights up when Progressive scanned signals on a DVD VIDEO disc are directly output as they are from the player.

Depending on the [PICTURE SOURCE] setting on the [PICTURE] preference display (see page 29) and whether the current DVD VIDEO disc is film-source or video-source, the progressive indicator lights, as shown in the table.

Setting of [PICTURE SOURCE]	Source type of DVD VIDEO	
	Film source	Video source
AUTO	DDP	P
FILM	DDP	DDP
VIDEO (NORMAL)/ (ACTIVE)	P	P

* While stopped in the Progressive scanning mode, [P] indicator is lit regardless of the [PICTURE SOURCE] selection.

NOTES

- The Progressive scanning mode works only when you connect the player's COMPONENT VIDEO OUT jacks to a progressive TV.
- There are some progressive TV and High-Definition TV sets that are not fully compatible with the player, resulting in the

- unnatural picture when playing back a DVD VIDEO disc in the Progressive scanning mode. In such a case, use the Interlaced scanning mode. To check the compatibility of your TV set, contact your local JVC customer service center.
- All JVC progressive TV and High-Definition TV sets are fully compatible with the player (Example: AV-61S902).

Connecting to optional audio equipment

Connecting to a stereo audio amplifier/receiver

Connect the player's AUDIO OUT (LEFT/RIGHT) jacks to any line-level inputs (such as AUX, DVD, CD, etc.) of an audio amplifier or receiver.

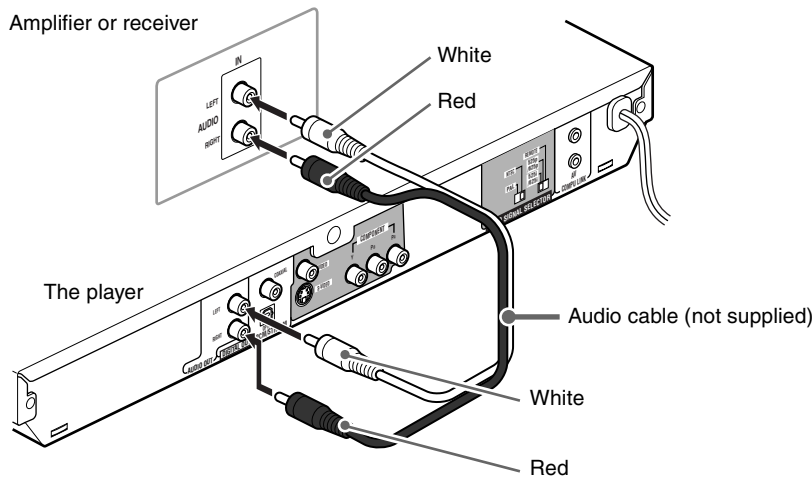

Connecting to a digital audio device

You can enjoy sound of enhanced quality by connecting the player's DIGITAL OUT (either OPTICAL or COAXIAL) jack to a digital input of an amplifier, etc., using an optical or coaxial digital cable. The digital audio signal on a disc will be transferred directly from the player. If the connected digital audio equipment is a Dolby Digital or DTS decoder or an amplifier with a built-in decoder, you can enjoy high-quality surround sound.

NOTES

- Connect the player and the digital audio device by using either an optical digital cable or a coaxial digital cable.
- It is not recommended to use the digital jacks for dubbing. When recording the sounds (DVD VIDEO, SVCD, Video CD or Audio CD) played back on the player, record them through the analog jacks.
- Depending on the disc, no signal may be output from the DIGITAL OUT. Make an analog connection in this case.
- **Set [DIGITAL AUDIO OUTPUT] in the [AUDIO] preference display correctly according to the connected digital audio equipment. If setting made for [DIGITAL AUDIO OUTPUT] is incorrect, loud noise may be generated causing damage to the speakers (see page 30).**

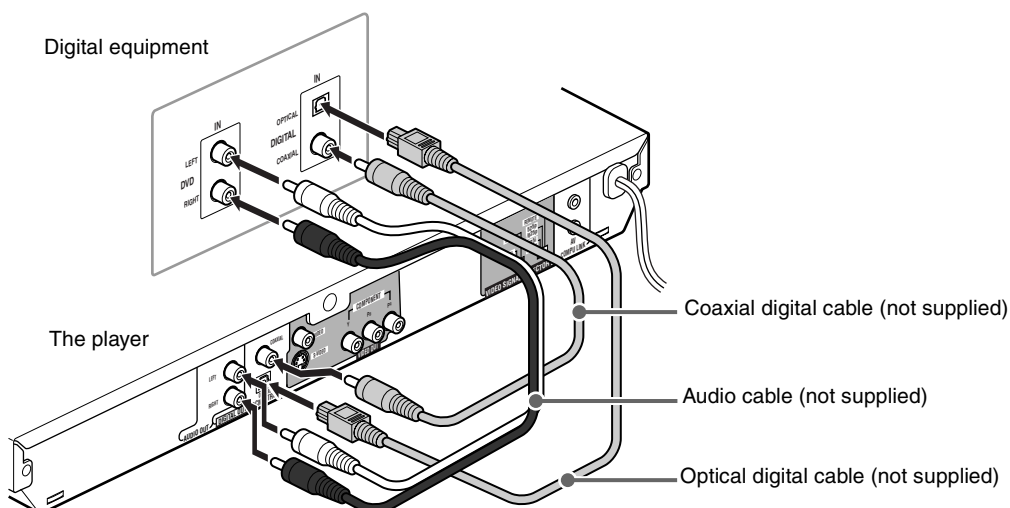

Preparations

Connecting the power cord

When all the audio/video connections have been made, connect the AC power plug to the wall outlet. Make sure that the plugs are inserted firmly.

The STANDBY/ON indicator lights in red.



Warning

- Disconnect the power cord:
 - if you are not going to use the player for a long time.
 - before cleaning the player.
 - before moving the player.
- Do not:
 - connect or disconnect the power cord with wet hands.
 - pull the power cord when disconnecting it, as this may damage the cord and cause fire, electric shock, or other accidents.



Caution

- Do not alter, twist or pull the power cord, or put anything heavy on it, which may cause fire, electric shock, or other accidents.
- If the cord is damaged, consult a dealer and have the power cord replaced with a new one.

Using the remote control unit

To install batteries

Open the compartment cover, and place the two supplied R6P (SUM-3)/AA(15F) batteries in the remote control unit according to the polarity markings (“+” and “-”) inside the compartment. Then replace the cover.

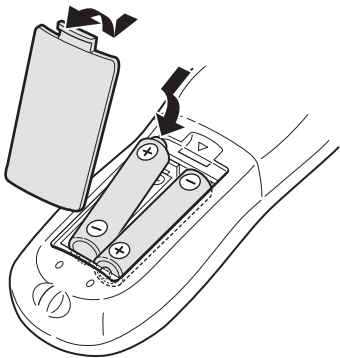

The batteries will last about six months with normal use. If the functions of the remote control unit become erratic, replace the batteries.

Precautions of the safe use of batteries

Observe the following precautions for the safe use of batteries. If they are used improperly their lives will be shortened, they may burst or their contents may leak.

- Remove the batteries from the remote control unit if it is not going to be used for a long period of time.
- Remove dead batteries and dispose of them properly.
- Never leave dead batteries lying around, take them apart, mix them with other refuse, or throw them into an incinerator.
- Never touch liquid that has leaked out of a battery.
- Do not mix new and old batteries, or batteries of different types, when replacing them.

Remote sensor

Point the top of the remote control unit toward the remote sensor as directly as possible. If you operate it from a diagonal position, the operating range (approx. 5 m) may be shorter.

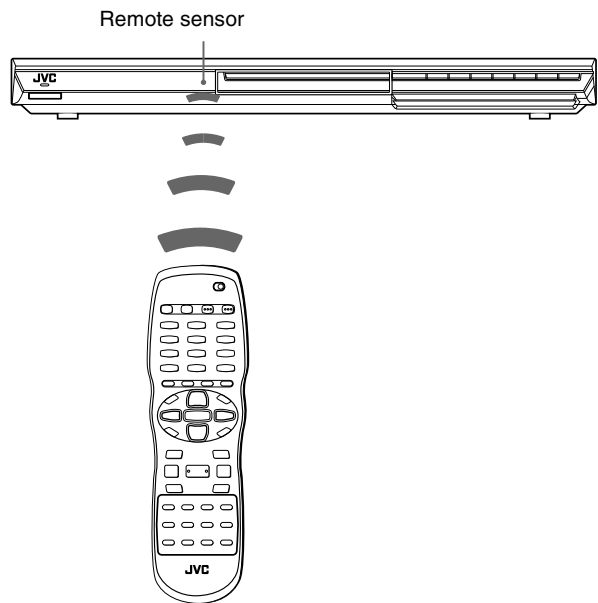

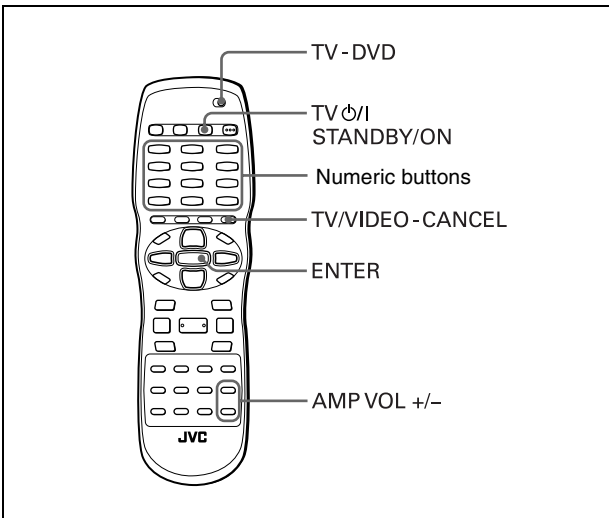

To use the remote control unit for TV operation

Setting the remote control signal for operating your TV

- 1 Set the TV - DVD switch to "TV."
- 2 While holding down TV/VIDEO - CANCEL, enter the manufacturer code of your TV listed below by using the numeric buttons (0 to 9), and then press ENTER.

Example:

To enter the manufacturer code "01": Press "0," "1," then ENTER.

Manufacturer code list

Manufacturer	No.	Manufacturer	No.
AIWA	36	MIVAR	29
BEIJING	22	NEC	20
CCE	02	NOBLEX	22
CHANGHONG	34	NOKIA	31
DAEWOO	17, 37	PANASONIC	04, 11
FERGUSON	27	PEONY	34, 38, 39
FINLUX	30	PHILCO	10, 17, 21
FUNAI	32	PHILIPS	02
GRADIENTE	15, 20	RCA	05
GRUNDIG	19	SAMSUNG	12, 33, 34, 35
HITACHI	10		
ITT	28	SANYO	13, 16
JINXING	38	SEARS	13
JVC	01, 23, 24, 25	SHARP	06
		SONY	07
KONKA	40	TCL	41
LG (GOLDSTAR)	18	THOMSON	26
MAGNAVOX	02	TOSHIBA	08, 14
MITSUBISHI	03	ZENITH	09

NOTE

These codes may not be compatible with TVs which are relatively old.

3 Release TV/VIDEO - CANCEL.

4 Try to operate the TV by pressing TV ⏻/STANDBY/ON .

If your TV turns on or off, you have successfully set the control signal.

NOTES

- When you purchased the player the manufacturer code is set to "JVC" (01).
- If there is more than one code listed for the manufacturer of your TV, try them one by one until you succeed.

Operating the TV

Set the TV - DVD switch on the remote control unit to "TV."



The following buttons can be used for operating the TV.

	Turns the TV on or off.
	Switches the TV input mode between TV and VIDEO.
	Selects the TV channels directly. *For some TVs, pressing "+10" functions as the "100+," while "10" functions as the ENTER button if your TV requires pressing the ENTER button after selecting a channel number.
	Mutes the TV sound.
	Changes the TV channels.
	Adjusts the TV sound volume.

To control the volume of a JVC's amplifier or receiver

Pressing the AMP VOL + button raises the audio volume of a JVC's amplifier or receiver, while pressing the - button lowers the volume.

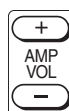

Basic operations

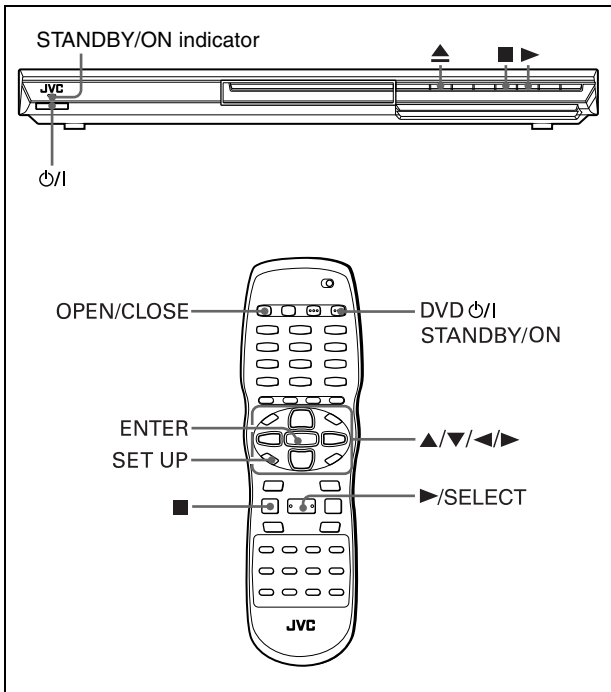

NOTE



Make sure that the TV - DVD switch on the remote control unit is set to "DVD" when using the $\blacktriangle/\blacktriangledown/\blacktriangleleft/\blacktriangleright$ and numeric buttons for controlling the player.

About invalid operation icon

When you press a button, and if the player does not accept its operation, \odot appears on your TV screen. Operations are occasionally unacceptable even if \odot is not displayed. Note that some operations may not be accepted. For example, some discs may not allow rapid advance/reverse or slow-motion playback.

Turning on/off the player

Press DVD ϕ/I STANDBY/ON on the remote control unit or press ϕ/I on the front panel.

The STANDBY/ON indicator on the front panel, which lights in red during standby, lights in green.

The left and right sides of the display window are illuminated.

The opening display appears on the TV screen, and the following messages may appear at the bottom of the opening display.

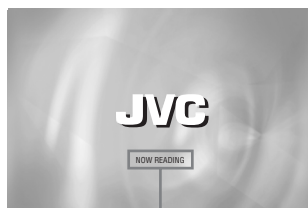

Message area

- NOW READING (The player is reading the disc information.)
- REGION CODE ERROR! (The region code of the DVD VIDEO disc does not match the player. The disc cannot be played back.)

- CANNOT READ THIS DISC (The player cannot play back the disc.)
- OPEN (The disc tray is opening.)
- CLOSE (The disc tray is closing.)
- NO DISC (No disc is loaded.)

NOTES

- Even if you turn off the player, the player is not disconnected from the AC power source as long as it is connected to the wall outlet. This state is called standby mode. In this state, the player consumes a very small amount of power.
- You can change the picture of the opening display. (See page 26.)

Initial setup

When you turn on the player for the first time, the following message appears on the TV screen.

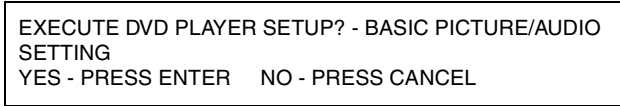

1 Press ENTER.

The first page of the DVD PLAYER SET UP display appears. The pull-down menu of the [ON SCREEN LANGUAGE] is already open.

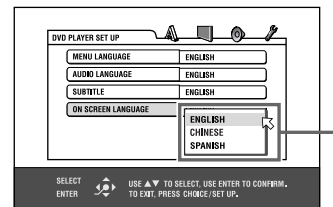

ON SCREEN LANGUAGE options

2 Press $\blacktriangle/\blacktriangledown$ to select the desired language.

You can select the on-screen language for the preference displays, etc. from among ENGLISH, CHINESE, and SPANISH.

3 Press ENTER.

The second page is shown, in which the pull-down menu of the [MONITOR TYPE] is already open.

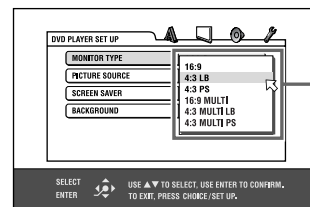

MONITOR TYPE options

4 Press $\blacktriangle/\blacktriangledown$ to select the desired monitor type.

For a normal (conventional) TV, select [4:3 LB] or [4:3 PS]. For a wide-screen TV, select [16:9]. For a multi-format TV, select [16:9 MULTI], [4:3 MULTI LB] or [4:3 MULTI PS] according to your TV's screen ratio. (See page 29.)

5 Press ENTER.

The third page is shown, in which the pull-down menu of the [DIGITAL AUDIO OUTPUT] is already open.

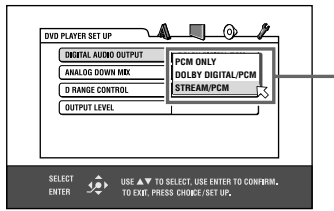

DIGITAL AUDIO OUTPUT options

6 Press ▲/▼ to select a desired digital output signal type.

Set this item correctly when you connect the player to an external surround decoder or D/A converter. See "DIGITAL AUDIO OUTPUT" on page 30. (If you do not connect the player to such a device, you do not have to set this item.)

- When connecting to other digital device, select [PCM ONLY].
- When connecting to a Dolby Digital decoder, select [DOLBY DIGITAL/PCM].
- When connecting to a Dolby Digital decoder/DTS decoder/MPEG decoder, select [STREAM/PCM].

7 Press ENTER.

The TV screen returns to the opening display.

To bring up the DVD PLAYER SET UP display later

Press SET UP for a few seconds until the DVD PLAYER SET UP display appears.

Basic playback

1 Press ▲ (or OPEN/CLOSE on the remote control unit) to open the disc tray.

2 Place a disc in the disc tray.

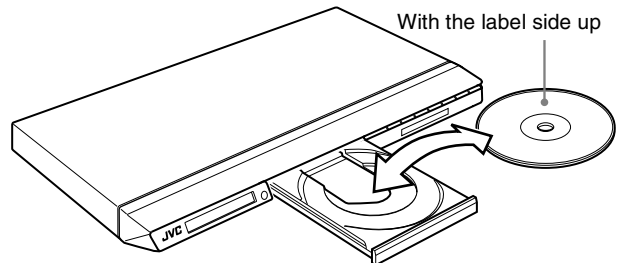

- To insert an 8-cm disc, place it in the inner recess.

3 Press ▲ (or OPEN/CLOSE on the remote control unit) to close the disc tray.

4 Press ► on the player or ►/SELECT on the remote control unit.

The player starts playback from the beginning.

- Depending on the disc, playback starts when you close the disc tray.

If a menu is shown on the TV screen

When inserting a DVD VIDEO, SVCD or Video CD disc, a menu may be shown on the TV screen. From the menu, you can select a desired item to be played back.

For DVD VIDEO

- 1 Press ▲/▼/◀/▶ to select a desired item.
- 2 Press ENTER.

The player starts playback of the selected item.

For SVCD/Video CD

Press the numeric buttons to select a desired item. The player starts playback of the selected item.

NOTES

- Do not insert an unplayable disc. (See page 2.)
- When inserting a disc on the disc tray, be sure to position the disc inside the recess. Otherwise, the disc may be damaged when the disc tray is closed, or you may not be able to remove the disc from the player.
- If it takes time to read the loaded disc ("READING" appears on the display window), remove the disc by pressing OPEN/CLOSE on the remote control and check the disc.

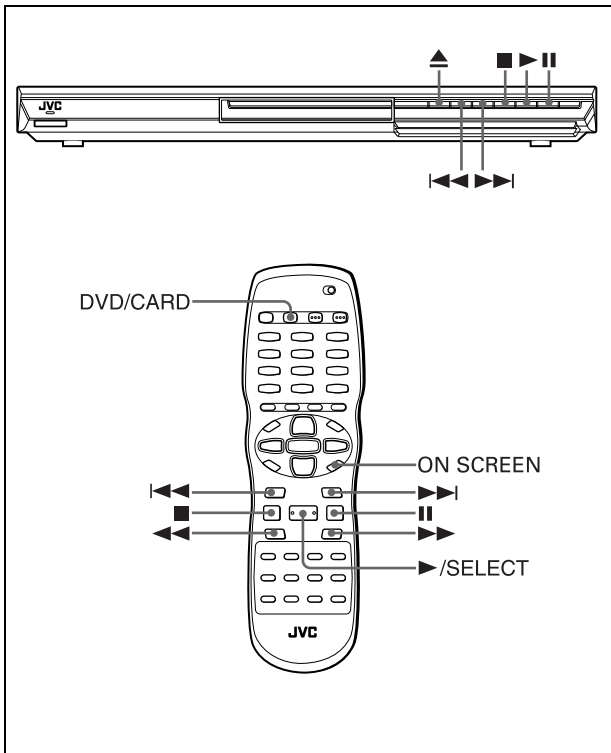

To check the playback status

You can see the current selection number (the title/chapter number for DVD VIDEO or track number for SVCD/Video CD/Audio CD), time information (the track or chapter time while stopped, or elapsed track or chapter time during playback) and the transport status (stop, playback, pause, etc.) on the TV screen.

Press ON SCREEN.

Example: for DVD VIDEO

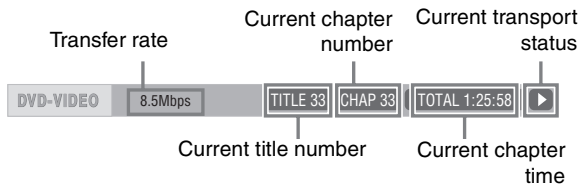

Note that pressing ON SCREEN again brings up the menu bar under the status bar, from which you can access various functions. See page 21 for details about the menu bar.

To turn off the status bar

Press ON SCREEN repeatedly until the status bar goes off.

To stop playback completely

Press ■.

Hint

If you press ▲ during playback, the player stops playback and opens the disc tray.

To stop playback temporarily

Press II.

To resume playback, press ►/SELECT. (See the following item.)

About On-screen guide icons

You may see the following icons displayed over the picture at the beginning of an operation. They have the following meanings.

- ▶ : Playback
- II : Pause
- ▶▶ / ◀◀ : Fast playback with the speed indication
- ◀◀ / ▶▶ : Slow-motion playback with the speed indication
- 👁️ : A scene recorded from multiple angles (see page 19)
- 🔊 : A scene recorded with multiple audio languages (see page 19)
- ⋮ : A scene recorded with multiple subtitle languages (see page 19)

You can change the setting so that the on-screen guide icons do not appear on the TV screen (see page 30).

Resuming playback



The player can memorize the position on a disc where you interrupt playback, and resume playback from that position later. There are three resume modes; ON, OFF and DISC RESUME. The mode is initially set to ON when you purchased the player.

- You can select the mode using the preference display (see page 30).

When the resume mode is “ON”

When you press ■, the player stops playback and memorizes the interrupted position. The TV screen shows “RESUME STOP” and [---- RESUME] (for DVD VIDEO) or [-- RESUME] (for SVCD/Video CD) appears in the display window.

The memory of the interrupted position is not cleared if you turn off the player.

When you turn off the player after setting the resume function, simply press ►/SELECT. The player is turned on, and playback starts from the interrupted position.

Note that the memory is cleared if you open the disc tray.

When the resume mode is “DISC RESUME”

When you press ■, the player stops playback and memorizes the interrupted position. The TV screen shows “RESUME STOP” and [---- RESUME] (for DVD VIDEO) or [-- RESUME] (for SVCD/Video CD) appears in the display window.

The memory of the interrupted position is not cleared if you open the disc tray or turn off the player.

Hint

The player memorizes interrupted positions for the last 30 discs played. Storing a new interrupted position will erase the interrupted position stored for the first disc.

To clear the memory

Press ■ while the disc is stopped.

To resume playback

When the resume mode is “ON”

While the disc you interrupted playback is still on the disc tray, press ►/SELECT.

The player resumes playback from the position where playback was interrupted. The TV screen shows “RESUME PLAY.”

To play back from the beginning

Press ■ before pressing ►/SELECT to start playback.

When the resume mode is “DISC RESUME”

1 Press ▲ to insert a disc for which the player has stored an interrupted position.

The TV screen shows “RESUME STOP.”

2 Press ►/SELECT.

The TV screen shows “RESUME PLAY” and the player resumes playback from the position where playback was interrupted.

To play back from the beginning

After inserting the disc, press ■ before pressing ►/SELECT to start playback.

When playing back a memory card

Pressing the DVD/CARD with a disc loaded clears the memory of the interrupted position.

To playback a memory card without clearing the memory of the interrupted position, do the following procedure.

- 1 Set the [RESUME] setting to [DISC RESUME].
- 2 Press ■.
- 3 Press ▲ to eject the disc.
- 4 Press DVD/CARD and start the memory card playback.

NOTES

- If you change the [RESUME] setting from [DISC RESUME] to [OFF] or [ON], you cannot resume playback of a disc whose “resuming” position is stored. However, when you again set [RESUME] to [DISC RESUME], you will then be able to resume playback of the disc.
- When you resume playback, set the [RESUME] setting to [DISC RESUME] before removing a loaded disc.
- If you interrupt the playback of a disc for which an interrupted position has already been stored, the memory will be updated with the new interrupted position.
- For a double-sided DVD VIDEO disc, the player regards each side as a different disc. Therefore, to resume playback of such a disc, the disc must be inserted with the same side down.
- When the player memorizes an interrupted point for a disc, it also memorizes Audio, Subtitle and Angle settings.
- The player may not resume playback exactly from the interrupted point. In the case of an SVCD/Video CD disc with PBC function, the player may resume playback from a point slightly earlier or later than the point where playback was interrupted.
- When you change Video CD playback mode to program or random play, the memory of the interrupted position goes off, then the player cannot resume playback.

Various speed playback

To advance or reverse playback rapidly while monitoring



During playback, press ►► or ◀◀ on the remote control unit.

You can select from 2 times (1.5 times for only the forward playback of DVD VIDEO), 5 times, 20 times and 60 times (for DVD VIDEO only) normal speed. Pressing ►/SELECT returns the player to normal playback.

During playback, hold down ►►| or |◀◀.

Playback is advanced or reversed at 5 times normal speed.

NOTE

During rapid playback, the sound will be muted except when playing an Audio CD, and when playing a DVD VIDEO at 1.5 times normal speed. For Audio CD, the sound will be heard intermittently.

x1.5 Quick Playback with sound



When you select 1.5 times normal speed playback, the disc is played back with sound.

- The subtitle does not go off.
- The sound may be heard intermittently.
- If the sound of a DVD VIDEO disc is recorded in Dolby Digital or DTS format, stereo linear PCM signals are output. With some DVD VIDEO discs, the sound quality and volume may alter, or the sound may be out of tune.
- To switch from rapid reverse playback to x1.5 Quick Playback, first press ►/SELECT, then press ►► once.

To advance a still picture frame by frame



While paused, press II.

Each time you press II, the still picture advances to the next frame.

Pressing ►/SELECT returns to normal playback.

To play back in slow motion



You can select from 1/32 times, 1/16 times, 1/4 times and 1/2 times normal speed.

During playback, press II, then press ►► (to play forward slow motion), or ◀◀ (to play reverse slow motion, for DVD VIDEO disc only).

Pressing ►/SELECT returns to normal playback.

NOTE

During slow motion playback, the sound will be muted.

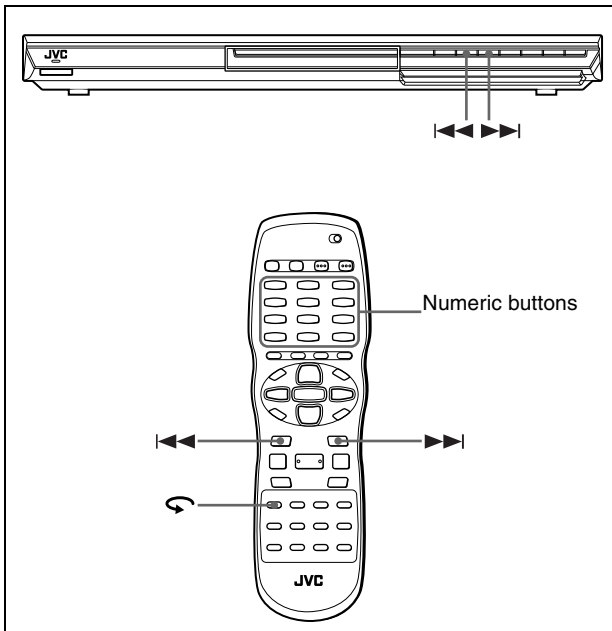

To replay the previous scenes (One touch replay function)



During DVD VIDEO playback, press .

The playback position moves back 10 seconds before the current position.

NOTES

- This function works only within the same title, though it works between chapters.
- This function may not work with some DVD VIDEO discs.

Locating the beginning of a scene or song



For DVD VIDEO: During playback, you can skip a chapter or title, depending on the disc configuration.
 For SVCD/Video CD: During playback without PBC function, you can skip a track.
 For Audio CD: During playback or while in stop mode, you can skip a track.

To skip forward, press .

To skip backward, press twice.

Using the numeric buttons

For DVD VIDEO/Audio CD: During playback or while in stop mode
 For SVCD/Video CD: During playback without PBC function or while in stop mode

Press the numeric buttons to specify the number.

- To select 5: press 5.
- To select 23: press +10, +10, then 3.
- To select 40: press +10, +10, +10, then 10.

The player starts playback from the beginning of the selection.

NOTES

- Depending on the disc type and the player status, what is specified differs:

Player status	Disc type	What is specified
While stopped	DVD VIDEO	title
	SVCD/Video CD/Audio CD	track
During playback	DVD VIDEO	chapter
	SVCD/Video CD/Audio CD	track

- During DVD VIDEO playback, if a menu is shown on the TV screen, the numeric buttons may be used for selecting an item in the menu.

About screen saver function

A television monitor may have an image burned into it if a static image is displayed for a long time. To prevent this, the player automatically activates the screen saver function if a static picture, such as an on-screen display or menu, is displayed for over 5 minutes.

When the screen saver function is activated, the TV screen gets darker.

Pressing any buttons will release the screen saver function. See "SCREEN SAVER" on page 29.

- The screen saver function does not work when playing back the following sources:
 - JPEG/MPEG-4 (while in pause)
 - Audio CD

Advanced operations

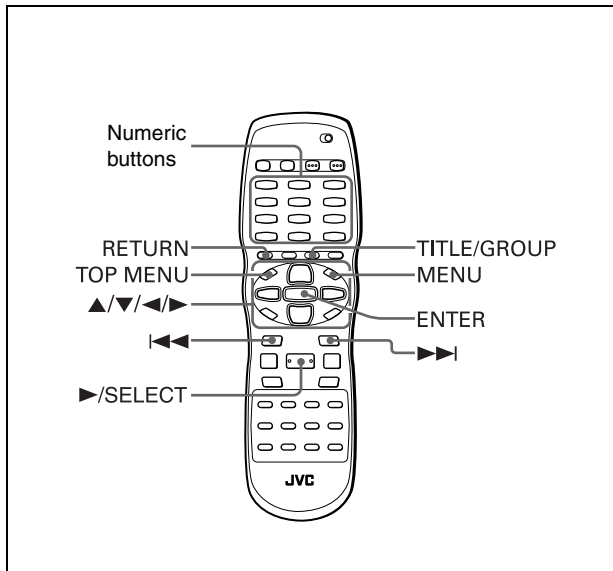

NOTE



Make sure that the TV - DVD switch on the remote control unit is set to "DVD" when using the ▲/▼/◀/▶, numeric and TV/VIDEO - CANCEL buttons for controlling the player.

Playing from a specific position

To locate a desired scene from the DVD menu



DVD VIDEO discs generally have their own menus which show the disc contents. These menus contain various items such as titles of movies, names of songs, or artist information, and display them on the TV screen. You can locate a desired scene using the DVD menu.

1 While a DVD VIDEO disc is inserted, press TOP MENU or MENU.

The menu appears on the TV screen.

2 Press ▲/▼/◀/▶ to select a desired item, then press ENTER.

The player starts playback of the selected item.

Hints

- Some DVD VIDEO discs may also have a different menu which appears when MENU is pressed.
- See the instructions of each DVD VIDEO disc for its particular menu.
- With some discs, you can select items by entering the corresponding number using the numeric buttons, which may cause the player to automatically start playback.

NOTE

The MENU button does not work while stopped.

To locate a desired scene from the menu of a SVCD/Video CD with PBC



Some SVCD/Video CD discs support the PBC function. PBC is an abbreviation of "Playback Control." Some SVCD/Video CD discs recorded with PBC have their own menus, such as a list of the songs of the disc. You can locate a specific scene by using the PBC menu.

1 In stop mode, press ►/SELECT.

A disc menu appears on the TV screen.

2 Press the numeric buttons to select the desired item.

To select 5: press 5.

To select 23: press +10, +10, then 3.

To select 40: press +10, +10, +10, then 10.

The player starts playback of the selected item.
To return to the menu, press RETURN.

Hint

If something like "NEXT" or "PREVIOUS" appears on the TV screen, pressing ►▶ advances to the next page, and pressing ◀◀ returns to the previous page.

About PBC (Playback Control)

Some SVCD/Video CD discs support the PBC function. The PBC function allows you to enjoy menu-driven operation and high-resolution still images which have a resolution four times greater than moving pictures.

- To play a PBC-compatible SVCD/Video CD disc without activating the PBC function, press the numeric buttons instead of ►/SELECT to start playback.
- To activate the PBC function again, press ■ to stop playback, then press ►/SELECT.

To specify a desired title



1 During playback, press TITLE/GROUP.

[--] is shown in the title display area of the display window.

2 Press the numeric buttons to specify a title to be played.

To select 5: press 5.

To select 23: press +10, +10, then 3.

To select 40: press +10, +10, +10, then 10.

The player starts playback from the specified title.

NOTE

This function may not work with some DVD VIDEO discs.

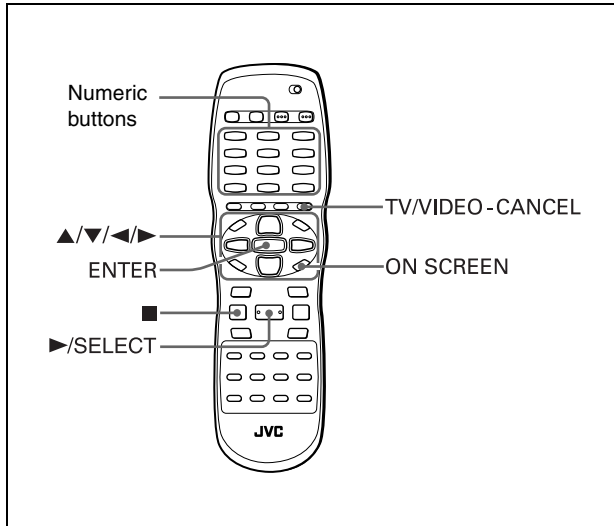

To locate a desired position in the current title or track (Time search)



You can play a disc from the desired position by specifying the time from the beginning of the current title (for DVD VIDEO) or the disc (for SVCD/Video CD/Audio CD).

For DVD VIDEO/Audio CD: During playback
 For SVCD/Video CD: In any condition except SVCD/Video CD playback with PBC

1 Press ON SCREEN twice.

The menu bar appears on the TV screen.

2 Press </> to move to [] , then press ENTER.

The pull-down menu for entering time appears.

Screen example for DVD VIDEO

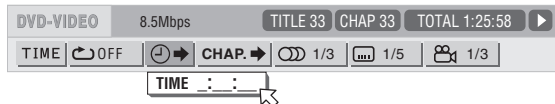

Screen example for Audio CD



3 Press the numeric buttons (0 to 9) to enter the desired time.

The specified time is displayed in the pull-down menu.

Example (for DVD VIDEO)

To play back from 2(H):34(M):00(S)
 Press 2, 3, then 4.



Example (for SVCD/Video CD/Audio CD)

To play back from 23(M):40(S)
 Press 2, 3, then 4.



You do not have to press "0" to enter the trailing zeros (for the last two digits in the example above).

To correct a mistake

Press < repeatedly to move back to the digit where you entered a wrong number, and reenter the correct one.

4 Press ENTER.

The player starts playback from the specified time.

To dismiss the menu bar

Press ON SCREEN.

Hint

"10" and "+10" buttons are not used with this function.

NOTES

- Some DVD VIDEO discs do not contain time information, and the time search function cannot be used.
- The time search function cannot be used during program playback.

Changing the playback order

To play back in a specific order (Program play)



By programming tracks, you can play up to 99 tracks in any order. You may program the same track more than once.

1 In stop mode, press ON SCREEN twice.

The menu bar appears on the TV screen.

2 Press ◀/▶ to move to PROG.

Screen example for Audio CD

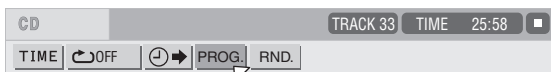

3 Press ENTER.

The program table appears.

The [PRGM] indicator lights up in the display window.

4 Press the numeric buttons to specify tracks in the desired order.

To select 5: press 5.

To select 23: press +10, +10, then 3.

To select 40: press +10, +10, +10, then 10.

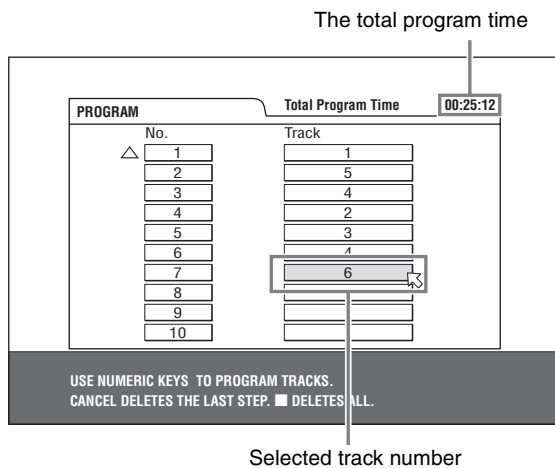

To correct the program

Press ▲/▼ to move  to the track to be corrected, then press TV/VIDEO - CANCEL. The track is erased and the subsequent programmed tracks move up.

Pressing ■ clears all the programmed tracks.

5 Press ▶/SELECT to start program playback.

With an Audio CD disc, the program table remains on the TV screen during program playback. (Pressing ON SCREEN brings up the status bar.)

When all of the programmed tracks have finished playback, the player stops and the program table appears again. Note that the program remains.

Note that the program remains.

- During program playback, you cannot edit the program contents.

To check the program contents

During playback, press ■. Playback stops and the program table is shown.

When the player is playing back an Audio CD and the program table is not shown, you can bring up the table by carrying out steps 1 to 3.

During SVCD/Video CD playback, you can check the program contents via the menu bar.

To stop program playback

Press ■.

To clear the program

While stopped and the program table is shown, press ■.

To exit the program mode

After clearing the program, press ON SCREEN.

NOTES

- When the disc tray is opened or the player is turned off, the program is cleared.
- During Audio CD playback, you can select previous or next tracks by pressing ▶▶/◀◀.
- During Video CD/SVCD playback, you cannot search for the portion on the discs by pressing ▶▶/◀◀.
- During program playback, you can repeat playback.

To play back in random order (Random play)



1 In stop mode, press ON SCREEN twice.

The menu bar appears on the TV screen.

2 Press ◀/▶ to move to RND.

Screen example for Audio CD

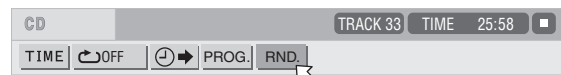

3 Press ENTER.

The player starts random playback.

With an SVCD/Video CD disc, the menu bar is automatically dismissed.

During random playback, the [RND] indicator lights up in the display window.

After playing all tracks of the disc, the player stops the disc and exits the random playback mode.

To stop and quit random playback

Press ■. The player stops playback and exits the random playback mode.

NOTES

- During random playback, you can repeat playback.
- Random playback mode will be canceled in the following cases:
 - When ejecting the loaded disc
 - When the Control screen appears on the TV
 - When turning off the power

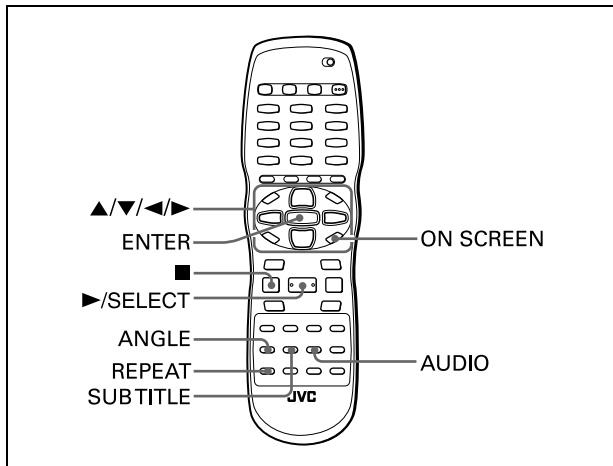

Repeat playback

To repeat the current selection or all tracks



For DVD VIDEO: During playback
 For SVCD/Video CD/Audio CD: In any condition except SVCD/Video CD playback with PBC

Press REPEAT.

If you press REPEAT in stop mode, press ►/SELECT to start playback.

Each time you press REPEAT, the repeat mode cycles among All repeat, Repeat 1 and off.

The indication on the display window shows the selected repeat mode.

: Repeats the current title for DVD VIDEO or all tracks for SVCD/Video CD/Audio CD.

1: Repeats the current chapter for DVD VIDEO or the current track for SVCD/Video CD/Audio CD.

No indication: The repeat mode is off.

A window which indicates the current repeat mode will be displayed on the TV screen. The mode indication on the window is same as the one on the menu bar.

(Repeat mode example on the TV screen)



To stop repeat playback

Press ■.

To quit repeat playback

Press REPEAT until the repeat mode indicator goes off in the display window.

Hint

When the program playback mode is active with an SVCD, Video CD or Audio CD, the repeat mode changes in the same manner.

Note, however, that in the " " mode the player repeats all the programmed tracks instead of all tracks on the disc.

To repeat a desired part (A-B repeat playback)



First make sure:

- The player is in playback mode except SVCD/Video CD playback with PBC.

1 Press ON SCREEN twice.

The menu bar appears on the TV screen.

2 Press ◀/▶ to move to , then press ENTER.

The pull-down menu for repeat mode selection appears.

3 Press ▲/▼ to select [A-B].

4 Press ENTER at the beginning of the part you want to repeat (point A).

The pull down menu disappears.

The repeat icon shows A- .

5 Press ENTER at the end of the part you want to repeat (point B).

The repeat icon shows A-B .

The player locates "A" and starts repeat playback between "A" and "B."

The [] indicator lights in the display window.

To quit A-B repeat playback

Press ◀/▶ to move to A-B , and press ENTER. The A-B repeat mode turns off, then normal playback continues.

NOTE

The A and B points must be set in the same title/chapter/track.

Changing the language, sound and scene angle

To select the subtitle language (SUBTITLE)



Some DVD VIDEO and SVCD discs contain more than one subtitle language. You can choose a desired one from them.

Hint

At the beginning of the part where the subtitles are recorded,  appears on the TV screen (except when the [ON SCREEN GUIDE] preference is set to [OFF]).

1 During playback, press SUBTITLE.

The subtitle selection window appears on the TV screen.

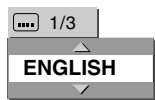

2 Press ▲/▼ or SUBTITLE to select the subtitle.

Each time you press ▲/▼ or SUBTITLE, the subtitle language changes.

3 Press ENTER.

Subtitles are displayed in the selected language.
The subtitle selection window is dismissed.

NOTES

- An SVCD disc can have up to four subtitles. Pressing ▲/▼ cycles through those channels regardless of whether the subtitles are recorded or not.
- The subtitle selection window will automatically disappear if you do not change the subtitle for several seconds.
- For DVD VIDEO, the selected language may be abbreviated on the TV screen. See "Appendix C: Table of languages and their abbreviations" on page 36.

To change the audio language or sound (AUDIO)



The audio selection setting allows you to change the audio language of a movie.

Hint

At the beginning of the part where multiple audio tracks are recorded,  appears on the TV screen (except when the [ON SCREEN GUIDE] preference is set to [OFF]).

1 During playback, press AUDIO.

The audio selection window appears on the TV screen.

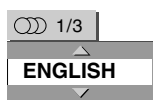

2 Press ▲/▼ or AUDIO to select the desired audio.

Each time you press ▲/▼ or AUDIO, the audio changes.

For DVD VIDEO (example)



For SVCD

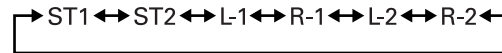

For Video CD

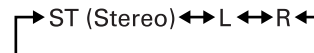

3 Press ENTER.

You can hear the selected audio.
The audio selection window is dismissed.

NOTES

- The audio selection window will automatically disappear if you do not change the audio for several seconds.
- For DVD VIDEO, the selected language may be abbreviated on the TV screen. See "Appendix C: Table of languages and their abbreviations" on page 36.
- Some discs may not allow this operation during playback.

To select a scene angle of DVD VIDEO (ANGLE)



You can enjoy a variety of scene angles if the DVD VIDEO disc contains "multi-angle" parts, where multiple cameras were used to shoot the same scene from different angles.

Hint

At the beginning of a "multi-angle" part,  appears on the TV screen (except when the [ON SCREEN GUIDE] preference is set to [OFF]).

1 During playback, press ANGLE.

The angle selection window appears on the TV screen.



2 Press ▲/▼ or ANGLE to select the desired angle.

Each time you press ▲/▼ or ANGLE, the angle changes.

3 Press ENTER.

You can see the picture from the selected angle.
The angle selection window is dismissed.

NOTE

The angle selection window will automatically disappear if you do not change the angle for several seconds.

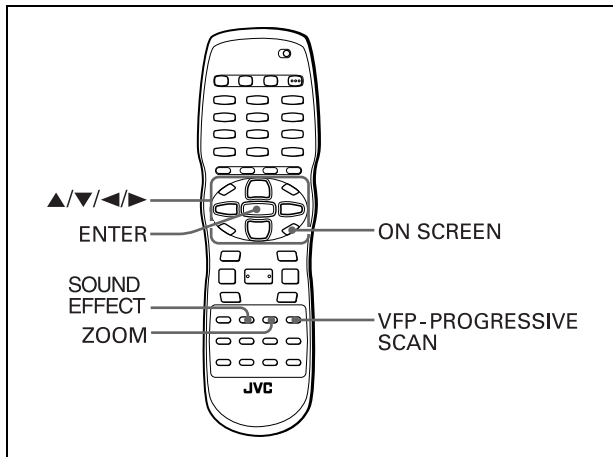

Special picture/sound effect

To zoom in pictures



1 During playback or while paused, press ZOOM.

Pressing ZOOM causes the player to zoom in on the image. Each time you press ZOOM, the magnification is changed (1.5, 2 and 4 times).

2 Press ▲/▼/◀/▶ to move the zoomed position.

To return to the normal playback

Select the normal size by pressing ZOOM repeatedly.

NOTE

While zoomed, the picture may look coarse.

To adjust the picture character (VFP)



The VFP (Video Fine Processor) function allows you to adjust the picture character according to the type of programming, picture tone or personal preferences.

1 During playback, press VFP - PROGRESSIVE SCAN.

The VFP mode selection window appears on the TV screen.

- If you press the VFP-PROGRESSIVE button too long, the button works for changing the scanning mode (see page 6) instead of the VFP function.

2 Press ◀/▶ to select the desired preset.

Each time you press the button, the VFP mode changes as follows.

Set the video type most suitable to the current program or the room conditions.

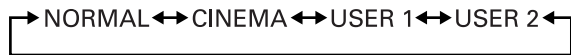

Selected preset

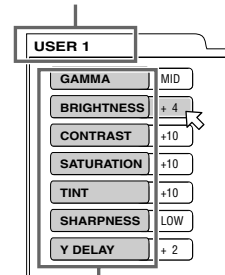

Parameter

[NORMAL]: for watching TV in a general room.

[CINEMA]: for watching a movie software in a room with suppressed light.

[USER 1] [USER 2]: you can adjust parameters that affect the picture character and store the settings as a user preset. See the next step.

3 To define a user setting, press ▲/▼ to select a parameter to be edited from the following.

- **GAMMA**
Adjust this if the neutral color is bright or dark. The brightness of dark and bright portion is maintained. Available range: LOW/MID/HIGH.
- **BRIGHTNESS**
Adjust this if the picture is bright or dark on the whole. Available range: -16 (darkest) to +16 (brightest).
- **CONTRAST**
Adjust this if the far and near position is unnatural. Available range: -12 to +12.
- **SATURATION**
Adjust this if the picture is whitish or blackish. Available range: -16 (blackest) to +16 (whitest).
- **TINT**
Adjust this if the appearance of flesh tone is unnatural. Available range: -16 to +16.
- **SHARPNESS**
Adjust this if the picture is indistinct. Available range: LOW/HIGH.
- **Y DELAY**
Adjust this if the picture looks separately/overlapped. Available range: -2 to +2.

4 Press ENTER.

A window for setting parameters appears.



Selected parameter

5 Press ▲/▼ to adjust the level of the parameter.

The higher value enhances the effect for each item other than "GAMMA" and "SHARPNESS."

6 Press ENTER.

Repeat steps 3 to 6 if you want to set other parameters.

To dismiss the VFP mode selection window

Press VFP - PROGRESSIVE SCAN.

NOTE

The window for VFP mode selection and parameter setting disappear if no operation is made for about 10 seconds.

To change sound field (SOUND EFFECT)



Using the Sound Effect function, you can change the sound field.

1 During playback, press SOUND EFFECT.

The Sound Effect indication appears on the TV screen.

2 Press SOUND EFFECT to select the desired mode.

Each time you press the button, the Sound Effect mode changes as follows:

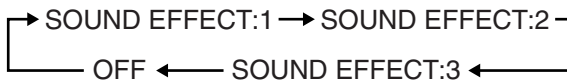

The [SE] indicator lights on the display window when the Sound Effect function takes effect.



- As the value becomes bigger, the Sound Effect works stronger.

To deactivate the Sound Effect

Press SOUND EFFECT repeatedly until "OFF" appears on the TV screen.

NOTE

The Sound Effect indication disappears if no operation is made for about few seconds.

Menu bar functions

To bring up the menu bar

1 When a disc is inserted, press ON SCREEN.

A status bar for the type of disc inserted will appear on the TV screen.

See page 12 for details about the status bar.

2 Press ON SCREEN again.

A menu bar for the type of disc inserted will appear under the status bar.

(for DVD VIDEO)



(for SVCD)

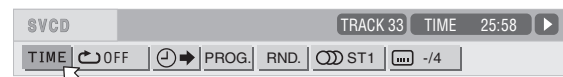

(for Video CD)

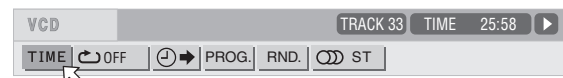

(for Audio CD)

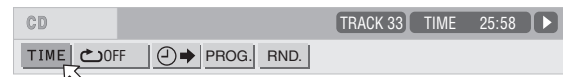

To dismiss the menu bar and status bar

Press ON SCREEN.

Basic operation procedure

1 Press to select the icon you want to work with.

The selected icon is pointed by .

2 Press ENTER.

With many icons, an appropriate pull-down window appears, however, there are some exceptions.

NOTES

- A mark or text on the menu icon for the function or mode currently selected is shown in green.
- Some functions are not available during playback. (You cannot move to the associated icon when it is not available.)

Menu bar functions for DVD VIDEO

Time mode selection

During playback, selects the time mode shown in the display window and in the status bar.

Press ENTER to select the time mode from the following.

- TOTAL: Current title elapsed time
- T.REM: Current title remaining time
- TIME: Current chapter elapsed time
- REM: Current chapter remaining time

Repeat mode (See also page 18)

Selects the repeat mode during playback.

1. Open the pull-down window.
2. Press ▲/▼ to select the repeat mode from the following.
 - CHAPTER: Current chapter repeat
 - TITLE: Current title repeat
 - A-B: A-B repeat
 - OFF: Repeat mode deactivated
3. Press ENTER to make the selected repeat function active.

Time search (See also page 16)

Specifies a time from the beginning of the current title as the point from which to begin playback.

Chapter search

During playback, specifies a desired chapter to be played back from.

1. Open the pull-down window.
2. Press numeric buttons (0 to 9) to enter a desired chapter number. (For example, to specify "10," press 1, then 0.)
3. Press ENTER to begin playback from the specified chapter.

Audio selection (See also page 19)

During playback, selects the audio language or sound track.

1. Open the pull-down window.
2. Press ▲/▼ to select a desired audio language or sound track.
3. Press ENTER to begin playback with the selected audio.

Subtitle selection (See also page 19)

During playback, selects the subtitle language.

1. Open the pull-down window.
2. Press ▲/▼ to select a desired subtitle language.
3. Press ENTER to begin playback with the selected subtitle.

Angle selection (See also page 19)

During playback, selects a desired scene angle in a multi-angle part.

1. Open the pull-down window.
2. Press ▲/▼ to select a scene angle.
3. Press ENTER to begin playback with the selected scene angle.

Menu bar functions for SVCD/Video CD/ Audio CD

Time mode selection

Selects the time mode shown in the display window and in the status bar.

Press ENTER to select the time mode from the following.

- TIME: Current track elapsed time
- REM: Current track remaining time (while in stop mode, current track total time)
- TOTAL: Disc elapsed time
- T.REM: Disc remaining time (while in stop mode, disc total time)

Repeat mode (See also page 18)

Selects the repeat mode.

1. Open the pull-down window.
2. Press ▲/▼ to select the repeat mode from the following.
 - TRACK: Current track repeat
 - ALL: All track repeat
 - A-B: A-B repeat
 - OFF: Repeat mode deactivated
3. Press ENTER to make the selected repeat function active.

Time search (See also page 16)

Specifies a time from the beginning of the disc as the point from which to begin playback.

Program playback (See also page 17)

While stopped, specifies the playback order of tracks.

Random playback (See also page 17)

While stopped, activates random playback.

Audio selection (See also page 19)

During SVCD/Video CD playback, selects the audio channel(s).

1. Open the pull-down window.
2. Press ▲/▼ to select a desired audio channel(s).
3. Press ENTER to play back with the selected audio channel(s).

Subtitle selection (See also page 19)

During SVCD playback, selects the subtitle.

1. Open the pull-down window.
2. Press ▲/▼ to select a desired subtitle.
3. Press ENTER to begin playback with the selected subtitle.

Audio/Video files playback

Outline

The player can play back MP3/WMA/JPEG/MPEG-4 (Simple profile) files on a personally recorded media as follows:

CD-R/RW, memory card, commercially available CD

The player can also play back MPEG-4 (Advanced simple profile) and DivX files recorded on CD-R/RW, DVD-R/-RW. Some DVD-R and DVD-RW discs mastered as multi border (multi-session) may not be compatible with the player.

You can select and play back files using the Control display on the TV screen.

- The player may be unable to play back the media due to the characteristics or recording conditions.

Precautions

About files and folders (groups) on the disc or the memory card

- Files are sometimes grouped into folders by genre, album, etc. In this manual, "group" is also referred to as "folder."
- A folder which has one or more files is regarded as a group.
- The player can detect and play back the groups which are located up to the fifth layer.
- The files in the Control display are arranged by the alphabetical order of extensions as follows: ".asf", ".avi", ".divx", ".jpeg", ".mp3", and ".wma".
- Time required for reading the media contents may vary for different media, depending on the numbers of folders (groups) and files recorded, etc.
- Files which do not belong to any folder are grouped into "group 1."
- The player recognizes up to 150 files per group, and up to 250 groups per disc/memory card. Files other than MP3/WMA/JPEG/MPEG-4/DivX files count in the 999 total.

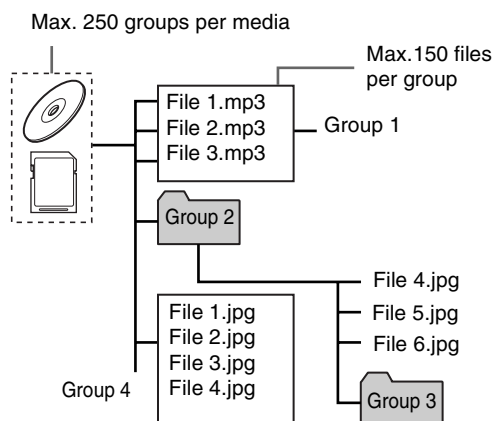

Notes for making your own disc

- Use "UDF format" as the disc format for DVD-R/-RW.
- Use "ISO 9660" as the disc format for CD-R/RW.
- The player does not support "packet writing" for CD-R/RW.
- The player supports discs recorded with up to five multiple sessions.
- Some disc may not play due to media characteristics or recording conditions.

Notes for making files/groups

- If a file name includes even one 2-byte character, the player may not show the file name correctly.
- The player supports up to 12 characters as the group/file names.
- The player can only recognize files with one of the following extensions, which can be in any combination of upper and lower case:
 - For MP3 files, ".MP3", ".mp3".
 - For WMA files, ".WMA", ".wma".
 - For JPEG files, ".JPG", ".JPEG", ".jpg", ".jpeg".
 - For MPEG-4 files, ".ASF", ".asf".
 - For DivX files, ".DIVX", ".DIV", ".divx", ".div" and ".AVI", ".avi".
- **For MP3 files:**
 - It is recommended that you record your material at a 44.1 kHz sampling rate, using the 128 kbps data transfer rate.
 - ID3 Tag is not available.
 - MP3i and MP3 Pro are not available.
- **For WMA files:**
 - WMA Tag is not available.
 - Make sure that the copyright feature is set to off.
 - We recommend you to record your material at a bit rate of 64 kbps or higher.
 - The player supports WMA files recorded with a bit rate of 48 kbps or higher. The player cannot play back WMA files recorded with a bit rate under 48 kbps.
- **For JPEG files:**
 - We recommend you to record your material at a 640 x 480 pixel resolution.
 - This player supports the baseline JPEG format.
 - The player does not support a baseline-formatted picture of more than 5120 x 3413 pixels. Make sure that the pictures pixel size is 5120 x 3413 pixels or less.
 - This player cannot play back a progressive JPEG file of more than 2048 x 1536 pixels.
- **For MPEG-4 files:**
 - The player supports the AVI files whose resolution is 640 x 480 pixels or less, and created using 4 Mbps ASP codec.
 - The size of the playback screen will be the same size as it is recorded.
 - Some recorded files may not be able to be played back depending on file characteristics, kind of digital still/video cameras, or recording conditions.
 - The player can playback the following MPEG-4 files:
 - MPEG-4 V2: Simple (single) stream
 - MPEG-4 V3: Fully supported
 - (MPEG-4 V1 file is not compatible.)
- **For DivX files:**
 - The player supports DivX 5.x, 4.x and 3.11.
 - The player supports the DivX files whose resolution is 720 x 480 pixels or less (30 fps), and 720 x 576 pixels or less (25 fps).
 - Audio stream should conform to MPEG 1 Audio Layer-2 or MPEG Audio Layer-3 (MP3).
 - The player does not support GMC (Global Motion Compression) and Q-PeI (Quarter Pixel).
 - The file encoded in the interlaced scanning mode may not be played back correctly.
 - The player has its own Registration Code for DivX playback. If necessary, you can confirm the Registration Code of your player using the OTHERS menu. (See page 31.)

Audio/Video files playback

Notes for inserting and removing memory cards

- Before you insert a memory card into a card slot, open the door on the front panel and make sure of the slot type and the direction of insertion as illustrated.
- Always use the single type of memory card at a time. When inserting the two or more types of memory card, "CHECK FOR CARD" appears on the TV screen.
- After inserting a memory card, close the door for playback. If the door is open, "CLOSE THE DOOR" appears on the TV screen and the player does not start the memory card playback.
- Stop both the memory card playback and the disc playback before inserting or removing memory card. When inserting or removing memory card during the disc playback, you cannot operate the player temporarily by static electricity and/or noise. In this case, disconnect the power plug and connect it again.
- When playing back a disc, always remove a memory card and close the card door.
- When playing back a disc, the electrostatic noise may restart the playback from the beginning.

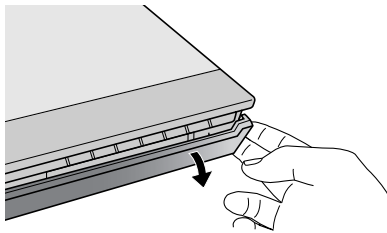

Press here to remove the inserted CompactFlash with the player held.

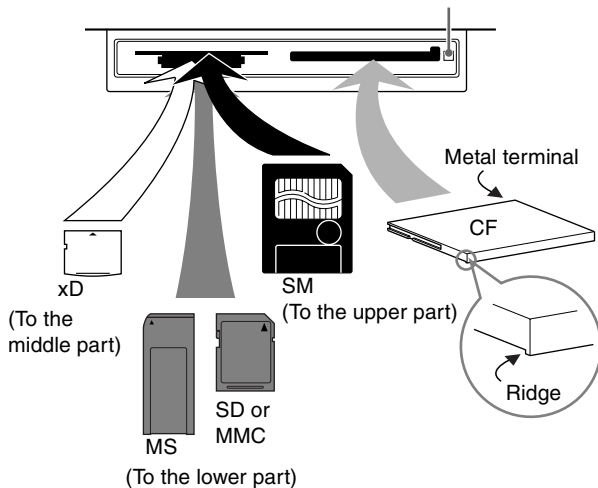

- When inserting or removing a memory card, hold the player firmly.
- When inserting an xD-Picture card, make sure that the front edge of the card is facing to the slot properly.

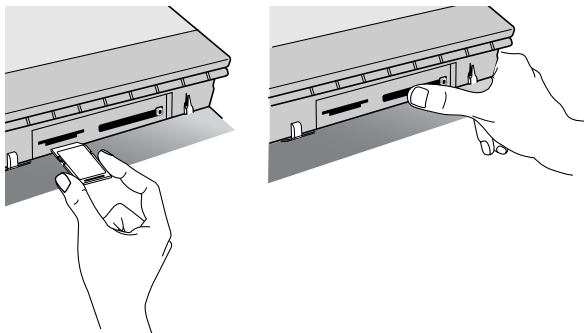

- Make sure the disc playback is stopped when inserting or removing the memory card.
- When inserting or removing the memory card, pay attention not to push any button on the player accidentally.

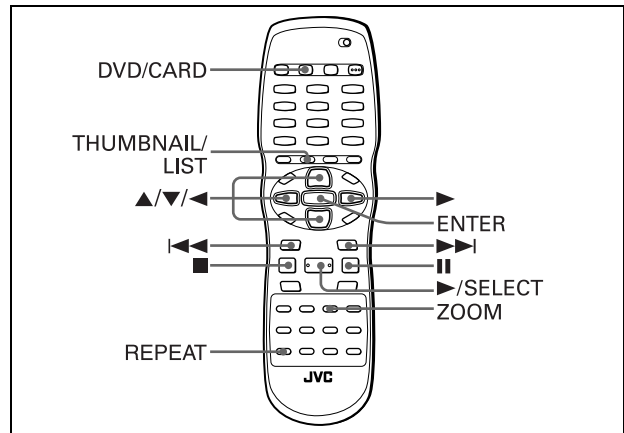

NOTE



Make sure that the TV - DVD switch on the remote control unit is set to "DVD" when using the $\blacktriangle/\blacktriangledown/\blacktriangleleft/\blacktriangleright$ and numeric buttons for controlling the player.

Basic operations

When you insert a disc or memory card with groups and files, the Control display that shows the contents of the medium automatically appears on the TV screen.

You can specify and play back the desired group/file from the Control display using the following procedure.

1 Make sure that the cursor bar is in the left (group) column on the Control display.

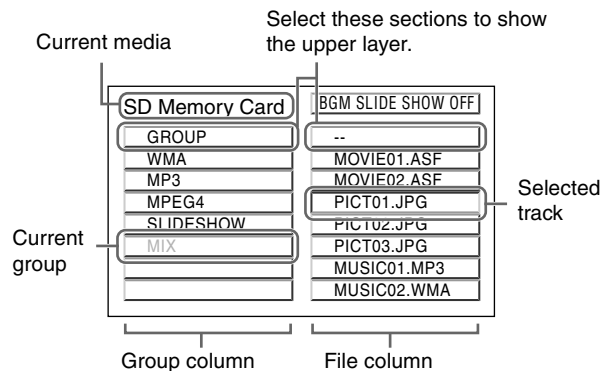

- If it is in the right column, press \blacktriangleleft to move it to the left column.
- If you want to select the other medium while both a disc and memory cards are inserted, press DVD/CARD before starting playback. When the player accesses a memory card, the [M CARD] indicator lights on the display window.

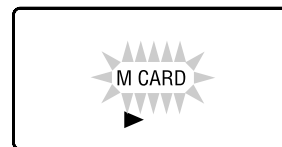

2 Press ▲/▼ to move the bar to a desired group, then press ENTER or ►/SELECT.

- In the right column, files in the selected group are shown.

3 Press ▲/▼ to select the desired file, then press ENTER.

- The selected file is played back.
- When you press ►/SELECT, the continuous playback starts from the selected file. The playback stops after playing back of all files in the same group.
 - You can also change the files on the list by pressing ◀◀/▶▶ or the numeric buttons.

To pause playback

Press ■. Pressing ►/SELECT resumes normal playback.

To reverse or advance playback rapidly

- Press ◀◀/▶▶ during playback of MP3/WMA/DivX.
- Each time you press ◀◀ or (▶▶), the player reverses (or advances) playback, rapidly changing the playback speed as follows:
 - For MP3/WMA files
x2, x4, x6, and x8
 - For DivX files
 - During rapid forward or reverse playback using ◀◀/▶▶, [◀◀1]/[▶▶1], [◀◀2]/[▶▶2], [◀◀3]/[▶▶3], or [◀◀4]/[▶▶4] appears on the TV screen. The higher the value is, the faster the playback speed is.

To zoom in a picture

- Press ZOOM.
- Each time you press ZOOM, the magnification is changed—
 - 1.5, 2 times, and 4 times for JPEG files
 - 2 times, and 4 times for MPEG-4 files
 - 2 times for DivX files
 - The four-time magnification may not work for some JPEG/MPEG-4 files according to their resolutions.
 - Pressing ▲/▼/◀/▶ moves the zoomed position during playback of JPEG file.
- To cancel the zoom function, select the normal size by pressing ZOOM repeatedly.

To rotate/reflect a still picture

- While the still picture is played back:
- Pressing ► rotates the picture by 90° clockwise.
 - Pressing ◀ rotates the picture by 90° counterclockwise.
 - Pressing ▼ reflects the picture vertically.
 - Pressing ▲ reflects the picture horizontally.

To stop playback

Press ■. The Control display appears on the TV.

NOTES

- Opening the card door or the disc tray stops playback.
- During slide show playback, you cannot rotate/reflect a picture.
- It may take time to show the Control display due to the layer configuration of the files and groups.
- The elapsed time may be incorrectly indicated on the display window due to the recording condition of the file.
- The display window cannot show the file number more than 100. When the files numbered over 100th are played back, the player re-counts file number again from 0.
- When the screen saver starts, the Control display disappears.
- The playback information appears on the TV as follows:
 - [READING INDEX] means that the player is reading the information of the selected MPEG-4/DivX file.
 - [CODEC. NOT SUPPORTED] means that the player cannot play back the selected MPEG-4/DivX file.

- [JPEG DATA ERROR] means that this player cannot play back the file.
- [JPEG DATA CORRUPTED] means that the file has error but the player can play back it.
- [OUT OF MEMORY] means that the pixel resolution of the JPEG file is too high. (See “Notes for making files/groups” on page 23.)
- [NEXT] means the player skips to the next file.
- [PREVIOUS] means the player skips to the previous file.
- [SELECT] means the file is selected on the thumbnail screen.

Direct selection for JPEG files

You can select a particular JPEG file from the thumbnail screen.

1 Press THUMBNAİL/LIST while a JPEG file is selected on the Control display.

- The thumbnail screen appears on the TV. Up to nine thumbnails from the selected file at a time can be displayed on the screen.
- When selecting a group on the Control display, the thumbnail screen does not appear.



2 Press ▲/▼/◀/▶ to select the desired picture on the thumbnail screen, then press ENTER.

- The desired picture is played back.
- You can change the thumbnails by pressing ◀◀/▶▶. All the JPEG files in the single group are displayed every nine thumbnails.

Repeat playback

During playback or while stopped, press REPEAT.

- Each time you press REPEAT while a file is selected, the repeat mode changes as follows:

Control display	Display window	Function
REPEAT 1	 1	Repeats the current file.
REPEAT GROUP		Repeats all files in the current group.
REPEAT ALL		Repeats all files on the media.
No indication	The repeat mode is off.	

If you press REPEAT while stopped, you need to press ENTER or ►/SELECT to start playback.

To stop repeat playback

Press ■. Note that the repeat mode remains active.

To quit repeat playback

- During playback, press REPEAT until no repeat icon is shown on the display window.
- While stopped, press REPEAT until the repeat mode indication on the Control display goes off.

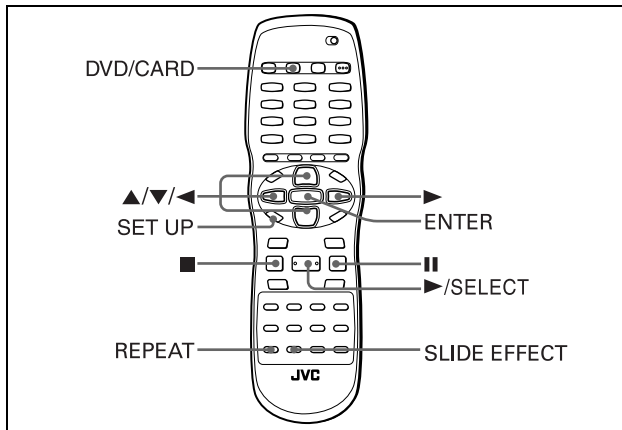

NOTE



Make sure that the TV - DVD switch on the remote control unit is set to "DVD" when using the ▲/▼/◀/▶ and numeric buttons for controlling the player.

Slide show playback

You can display files (still pictures) one after another automatically.

Press >/SELECT while a JPEG file is selected on the Control display.

The slide show starts from the beginning of the media.

- The display time varies in size of each file.

To change the effect on displaying images

You can select the effect of slide show.

Press SLIDE EFFECT.

"SLIDE EFFECT MODE :." and the current mode appear on the TV screen.

- Each time you press the button, the effect is changed as follows:

Mode	Type of wipe
1	Scroll wipe 1: The next image slides in from top to bottom.
2	Scroll wipe 2: The next image slides in from bottom to top.
3	Shutter wipe 1: The next image slides in vertically from both sides to center.
4	Shutter wipe 2: The next image slides in vertically from center to both sides.
5	Blind wipe 1: The next image slides in vertically through 4 slits.
6	Slide wipe 1: The next image slides in from left to right.
7	Slide wipe 2: The next image slides in from right to left.
8	Door wipe 1: The next image slides in horizontally from both sides to center.
9	Door wipe 2: The next image slides in horizontally from center to both sides.
10	Window wipe: The next image slides in from each side to center.
11	Blind wipe 2: The next image slides in horizontally through 4 slits.
RANDOM	The player selects and applies the effect to each image randomly.
NONE	Cancels the effect.

To stop slide show playback in the middle

Press ■.

The TV screen returns to the Control display.

- Pressing >/SELECT resumes slide show playback from the last picture displayed.

To keep showing the current picture

Press ||.

- Pressing >/SELECT resumes slide show playback.

NOTES

- During slide show playback, you cannot use the thumbnail and rotate/reflect functions.
- During the slide show playback of progressive JPEG files, you cannot change the effect.

Changing the picture of the opening display

You can change and set the opening display to your favorite image. See page 30.

1 Play back a JPEG file to be displayed as the opening display.

When selecting a JPEG file from the thumbnail screen or the slide show playback, press || to pause the slide show.

2 Press SET UP and ◀/▶ to show PICTURE menu of the on-screen menu.

3 Press ▲/▼ to select [BACKGROUND], then press ENTER.

4 Press ▲/▼ to select [SAVE AS BACKGROUND], then press ENTER.

5 Press ▲/▼ to select [YES], then press ENTER.

The player starts reading the selected JPEG file, and the opening screen is changed after reading the file.

- The previous picture for the opening screen is overwritten by the newly saved file.

To dismiss the menu screen

Press SET UP.

To resume the JVC's opening screen

Select [STANDARD] in step 4.

BGM slide show playback

During slide show playback of JPEG files on the memory card, you can play back Audio CDs or MP3 files as background music (BGM).

When you play back MP3 files as background music, make a group containing both JPEG files and MP3 files on the memory card.

- You cannot play Audio CDs with DTS or WMA files as background music.
- BGM slide show is available for JPEG files on the single group.
- BGM slide show may not work correctly for the progressive JPEG format.

Slide show with Audio CD playback

1 Insert an Audio CD.

- When a memory card is playing back, playback will stop.

2 Insert a memory card containing JPEG files.

3 Close the door cover.

The Control display of the memory card appears on the TV.

- When the memory card containing JPEG files is already selected, press DVD/CARD.
- When the memory card has two or more groups containing JPEG files, select the JPEG file in the group.

4 Select “BGM SLIDE SHOW OFF” on the Control display by pressing ▲/▼/◀/▶, then press ENTER to change to “BGM SLIDE SHOW ON.”

- Each time you press ENTER, the playback mode alternates between “BGM SLIDE SHOW ON (BGM slide show playback)” and “BGM SLIDE SHOW OFF (normal playback)”.

5 Select a JPEG file on the Control display, then press ►/SELECT.

The first track on the Audio CD is played back and BGM slide show starts.

- During BGM slide show, you can select the track on the Audio CD by pressing ◀◀/▶▶ or numeric buttons.
- The playback of the Audio CD stops after all the JPEG files are played back.
- When a track on an Audio CD is played back, the time and track indication is not displayed on the window.

Slide show with MP3 playback

- Before starting the following procedure, remove the disc from the disc tray.

1 Insert a memory card containing a group with both JPEG files and MP3 files.

2 Close the door cover.

The Control display for the media appears on the TV.

3 Select “BGM SLIDE SHOW OFF” on the Control display by pressing ▲/▼/◀/▶, then press ENTER to change to “BGM SLIDE SHOW ON.”

- Each time you press ENTER, the playback mode alternates between “BGM SLIDE SHOW ON (BGM slide show playback)” and “BGM SLIDE SHOW OFF (normal playback)”.

4 Select JPEG file on the Control display, then press ►/SELECT.



The player plays back the MP3 file from the beginning in the group and BGM slide show starts.

- You can change the MP3 files by pressing ◀◀/▶▶.
- You cannot select MP3 files on the other group.
- The playback of MP3 files stops after all the JPEG files are played back.

To repeat BGM slide show playback

Press REPEAT before BGM slide show playback.

- Each time you press REPEAT, the repeat mode changes as follows:

Control display	Display window	Function
REPEAT 1	 1	Repeats the current JPEG file.
REPEAT GROUP		Repeats all JPEG files in the current group.
No indication	The repeat mode is off.	

To stop BGM slide show playback in the middle

Press ■.

JPEG playback pauses.

When you press ■ again, BGM playback also pauses.

- Pressing ►/SELECT or ■ resumes music slide show playback from the last picture displayed.

To stop BGM slide show playback

Press ■.

BGM slide show playback is canceled (“BGM SLIDE SHOW OFF” is displayed on the Control display).

Changing the initial settings

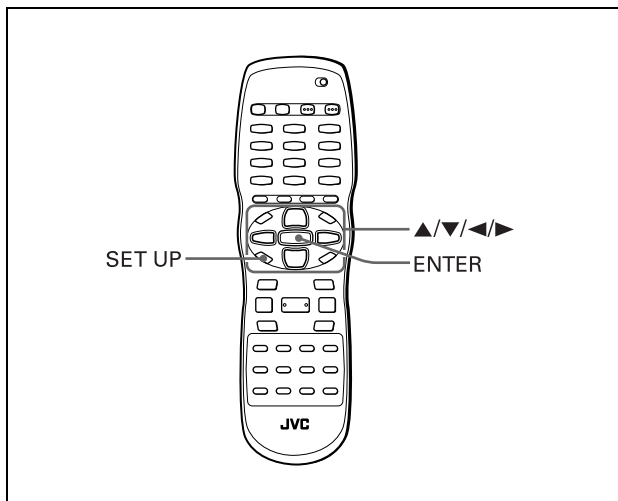

NOTE



Make sure that the TV - DVD switch on the remote control unit is set to "DVD" when using the $\blacktriangle/\blacktriangledown/\blacktriangleleft/\blacktriangleright$ and numeric buttons for controlling the player.

Selecting preferences

This section refers to the settings which are already made when you purchase the player. Read this section when you want to connect this player to a wide-vision TV set, or when you want to otherwise change the settings according to your preferences and viewing environment.

About the Preference display

The Preference display consists of the LANGUAGE, PICTURE, AUDIO and OTHERS setting displays, each having setting items.

LANGUAGE

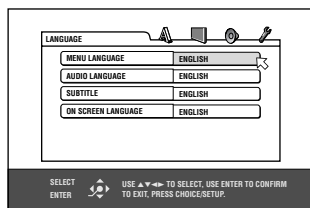

PICTURE

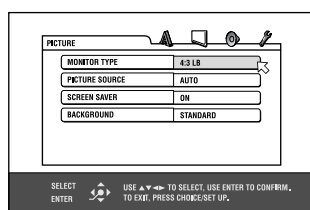

AUDIO

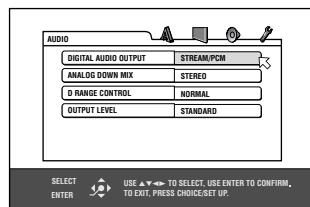

OTHERS

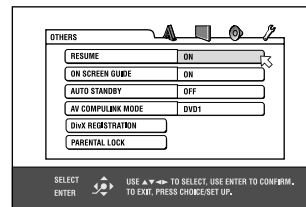

How to set preferences

1 Press SET UP.

One of the preference on-screen displays appears on the TV screen.

You can see four icons at the top right of the on-screen display for the settings.

\blacktriangle : LANGUAGE menu

\square : PICTURE menu

\odot : AUDIO menu

key : OTHERS menu

2 Press $\blacktriangleleft/\blacktriangleright$ to select the appropriate icon.

The appropriate display appears on the TV screen.

3 Press $\blacktriangle/\blacktriangledown$ to move key to select the item you want to edit.

The color of the selected item changes.

4 Press ENTER.

A pull-down menu appears over the selected item.

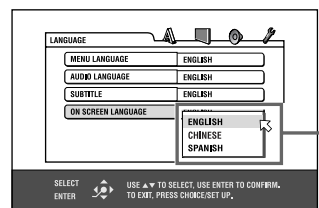

Selected item

5 Press $\blacktriangle/\blacktriangledown$ to select from the options then press ENTER.

The selected option is set.

- For details about each setting, see the following.

To dismiss a preference display

Press SET UP.

NOTES

- Some items cannot be changed during disc playback.
- When a preference display is shown on a wide TV screen, the upper and lower parts of the preference display sometimes may be cut off. If this happens, adjust the picture size control of the TV.
- When a preference display is shown, you cannot start playing back a disc.

LANGUAGE menu

MENU LANGUAGE

You can select the default menu language to be displayed if it is contained on a DVD VIDEO disc.

Setting options

ENGLISH, SPANISH, FRENCH, CHINESE, GERMAN, ITALIAN, JAPANESE, language code from AA to ZU

- If the disc does not have a menu in the selected language, the disc's default language will be used.
- For details about language codes, see "Appendix C: Table of languages and their abbreviations" on page 36.
- You cannot change the setting during playback.

AUDIO LANGUAGE

You can select the default audio language to be played if it is contained on a DVD VIDEO disc.

Setting options

ENGLISH, SPANISH, FRENCH, CHINESE, GERMAN, ITALIAN, JAPANESE, language code from AA to ZU

- If the disc does not have the selected language, the disc's default language will be used.
- For details about language codes, see "Appendix C: Table of languages and their abbreviations" on page 36.
- You cannot change the setting during playback.

SUBTITLE

You can select the default subtitle language to be displayed if it is contained on a DVD VIDEO disc.

Setting options

OFF, ENGLISH, SPANISH, FRENCH, CHINESE, GERMAN, ITALIAN, JAPANESE, language code from AA to ZU

- If the disc does not have a subtitle in the selected language, the disc's default language will be used.
- For details about language codes, see "Appendix C: Table of languages and their abbreviations" on page 36.
- You cannot change the setting during playback.

ON SCREEN LANGUAGE

You can select the on-screen display language of the player.

Setting options

ENGLISH, CHINESE, SPANISH

- Some on-screen messages are shown in English regardless of the setting.
- You cannot change the on-screen language shown on the Control display.

PICTURE menu

MONITOR TYPE

You can select the monitor type to match your TV when you play back DVD VIDEO discs recorded for wide-screen televisions.

Setting options

16:9, 4:3 LB, 4:3 PS, 16:9 MULTI, 4:3 MULTI LB, 4:3 MULTI PS

[16:9] (Wide television screen): select when you connect the player to a wide-screen (16:9) TV.

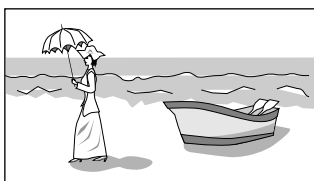

[4:3 LB] (Letter Box conversion): select when you connect the player to a normal (4:3) TV.

When playing back a DVD VIDEO disc recorded in wide picture format, the picture is shown with black bars at the top and bottom.



[4:3 PS] (Pan Scan conversion): select when you connect the player to a normal (4:3) TV.

When playing back a DVD VIDEO disc recorded in wide picture format, the picture is zoomed to fill the screen vertically, and the left and right sides of the image are chopped off.

Note, however, that the picture will be shown in the 4:3 LB mode even if you select the 4:3 PS mode depending on the disc.

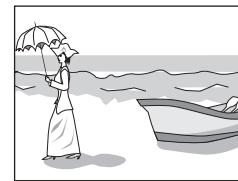

[16:9 MULTI] [4:3 MULTI LB] [4:3 MULTI PS]: These "MULTI" options should be selected when you connect the player to a TV that supports both the PAL and NTSC systems. If you select one of these options, the player outputs a PAL or NTSC video signal according to the disc, regardless of the VIDEO SIGNAL SELECTOR setting.

PICTURE SOURCE

This mode selects whether the content on the disc is processed by field (video source) or by frame (film source). You can obtain optimal picture quality according to the source type to be played back by selecting an appropriate option. This setting is available for both the interlaced mode and progressive scanning mode.

Setting options

VIDEO(NORMAL), VIDEO(ACTIVE), FILM, AUTO

[VIDEO(NORMAL)]: select when playing back a video source disc with relatively a few movements.

[VIDEO(ACTIVE)]: select when playing back a video source disc with relatively a lot of movements.

[FILM]: select when playing back a film source disc.

[AUTO]: select when playing back a disc containing both video and film source materials.

The player recognizes the picture type (film or video source) of the current disc according to the disc information. Normally, select this option.

SCREEN SAVER

You can set the screen saver function to ON or OFF. (See page 14.)

Setting options

ON, OFF

Changing the initial settings

BACKGROUND

You can change and set the opening display to your favorite image using this menu.

Setting options

STANDARD, USER, SAVE AS BACKGROUND

[STANDARD]: select when you use the JVC original image as the opening display (initial setting).

[USER]: select when you use your favorite image as the opening display. This item will be taken effect after you register a new image in the next item.

[SAVE AS BACKGROUND]: select when you register a new image. To register a new image, see "Changing the picture of the opening display" on page 26.

AUDIO menu

DIGITAL AUDIO OUTPUT

To connect the player's digital output to an external device equipped with a digital input, this item must be set correctly. See "Appendix A: Digital output signal chart" on page 35 for details about the relation between the setting and output signals.

Setting options

PCM ONLY, DOLBY DIGITAL/PCM, STREAM/PCM

[PCM ONLY]: select when you connect the DIGITAL OUT jack of the player to the linear PCM digital input of other audio equipment.

[DOLBY DIGITAL/PCM]: select when you connect the digital input of a Dolby Digital decoder or an amplifier with a built-in Dolby Digital decoder.

When this option is selected, playing back a disc recorded by the MPEG Multichannel format outputs a linear PCM digital signal.

[STREAM/PCM]: select when you connect the digital input of an amplifier with a built-in DTS, MPEG Multichannel or Dolby Digital decoder, or the stand-alone unit of such a decoder.

- With some DVD VIDEO discs that are not fully copy-protected, a 20 or 24 bit digital signal may be output.
- When playing a DVD VIDEO or Audio CD disc with DTS, use a DTS decoder to get correct signals from your speakers.

ANALOG DOWN MIX

To correctly play the audio on a DVD VIDEO disc recorded with surround multichannel audio, you must set this item properly according to your audio system configuration.

Setting options

DOLBY SURROUND, STEREO

[DOLBY SURROUND]: select when listening to multichannel surround audio with the player's analog AUDIO OUT terminals connected to a surround decoder.

[STEREO]: select when listening to conventional two-channel stereo audio with the player's AUDIO OUT terminals connected to a stereo amplifier/receiver or television set, or in case you want to record the audio from a DVD VIDEO disc to MiniDisc, cassette, etc.

D. RANGE CONTROL

This setting provides optimal audio quality from the analog AUDIO OUT terminals for listening to DVD VIDEO discs recorded in Dolby Digital format, at low or middle volume.

Setting options

WIDE RANGE, NORMAL, TV MODE

[WIDE RANGE]: when selected, audio is played back with the widest dynamic range so that you can enjoy powerful playback sound.

[NORMAL]: normally, select this option.

[TV MODE]: select if DVD VIDEO disc sound level is lower than TV program sound level. Thus you can hear sound at a lower volume clearly.

OUTPUT LEVEL

This setting allows you to attenuate the level of the signal output from the player's analog AUDIO OUT terminals.

Setting options

STANDARD, LOW

- If the sound output from the speaker is distorted, select [LOW].

OTHERS menu

RESUME

You can select the resume playback mode.

See pages 12 and 13 for details about the resume playback function.

Setting options

ON, OFF, DISC RESUME



[ON]: when selected, the player can resume playback of the disc from the position where playback was last interrupted, if the disc is still in the disc tray.

[OFF]: when selected, the resume function is deactivated.

[DISC RESUME]: when selected, the player can resume playback of the last 30 discs played. The player retains a memory of the interrupted positions of the last 30 discs played, even though they have been removed from the disc tray.

ON SCREEN GUIDE

The player can display "on-screen guide" icons or characters on the picture, which show what is happening to the disc or the player.

Example of "on-screen guide" icons:  ,  , 

Setting options

ON, OFF

[ON]: when selected, the on-screen guide is activated.

AUTO STANDBY

When the player is stopped for more than 30 minutes or 60 minutes, the player enters standby mode automatically.

Setting options

60, 30, OFF

AV COMPULINK MODE

You must set this item correctly to use the AV COMPU LINK system.

Setting options

DVD1, DVD2, DVD3

- See page 33 for details about the AV COMPU LINK function.

DivX REGISTRATION

The player has its own Registration Code for DivX playback. You can confirm the code of your player.

- Once you played back a disc created by using the Registration Code, the player's code is overwritten by a totally different new one for copyright protection purpose.

PARENTAL LOCK

When this option is selected, pressing ENTER on the remote control unit brings up the PARENTAL LOCK display shown below. This allows you to restrict children from playing DVD VIDEO discs.

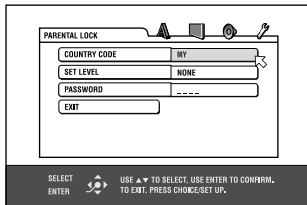

- See this page for details about the parental lock setting.

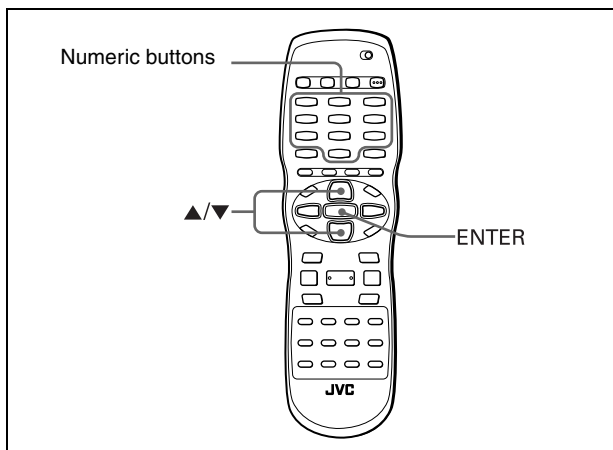

Limiting playback by children

This function restricts playback of DVD VIDEO discs which contain violent (and other) scenes according to the level set by the user. For example, if a movie which includes violent scenes supports the parental lock feature, such scenes which you do not want to let children view can be cut or replaced with other scenes.

To set Parental Lock for the first time



- Bring up the OTHERS menu.
- Press ▲/▼ to move to select [PARENTAL LOCK] then press ENTER.

The Parental Lock on-screen display appears on the TV screen.

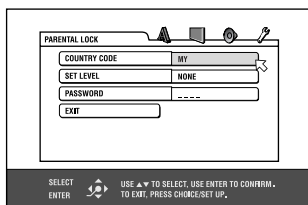

- While is pointing to [COUNTRY CODE], press ENTER to bring up the pull-down menu.

- Press ▲/▼ to select the country code.

Select the code of the country whose standards were used to rate the DVD VIDEO disc content.

See "Appendix B: Country/Area code list for Parental Lock" on page 36.

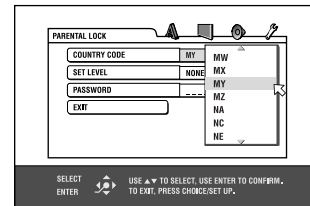

- Press ENTER.

moves to [SET LEVEL].

- Press ENTER to bring up the pull-down menu.

In the pull-down menu, [NONE] and levels [8] to [1] are available.

[NONE] does not restrict playback. Level [1] is the strictest level. Discs rated higher than the selected level are restricted.

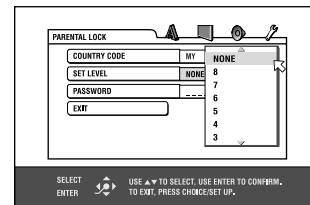

- Press ▲/▼ to select a desired parental lock level, then press ENTER.

moves to [PASSWORD].

- Press the numeric buttons (0 to 9) to enter a 4-digit password.

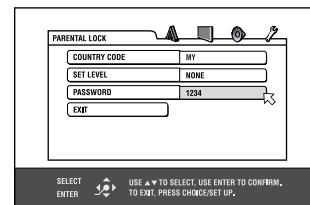

- Press ENTER.

The parental lock feature is set.

moves to [EXIT]. Pressing ENTER again returns to the [OTHERS] menu of the preference display.

Hint

If you want to change the password at step 8, do it before pressing ENTER.

Changing the initial settings

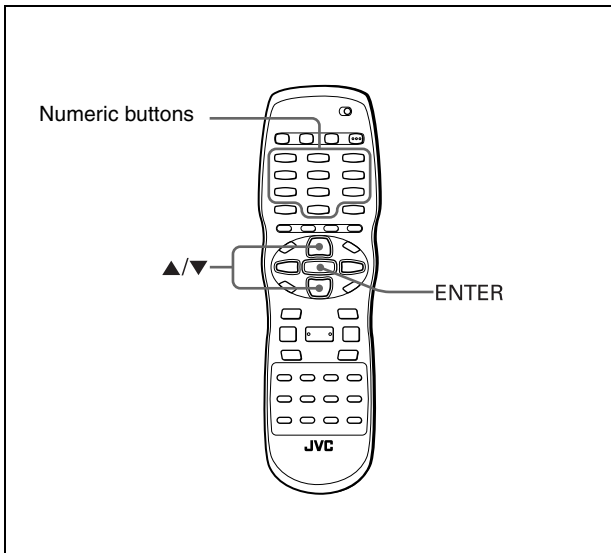

To change the settings



You can change the parental lock settings later.

- 1 Bring up the OTHERS menu.**
- 2 Press ▲/▼ to move  to select [PARENTAL LOCK] and press ENTER.**

The parental lock on-screen display appears on the TV screen.

- 3 While  is pointing to [PASSWORD], press the numeric buttons to enter your current 4-digit password then press ENTER.**

 moves to [COUNTRY CODE] if you enter the correct password.

If you enter a wrong password, "WRONG! RETRY..." appears on the TV screen, and you cannot go to the next step. If you forget your password, enter "8888." The current password is deleted and you can set a new password.

- 4 To change the [COUNTRY CODE] or [SET LEVEL], press ENTER to bring up the associated pull-down menu when  is pointing to the desired item.**

- 5 Press ▲/▼ to select the desired option then press ENTER.**

If you change the country code, you must reselect the parental lock level.

- 6 While  is pointing to [PASSWORD], press the numeric buttons to enter a 4-digit password.**

The password entered in this step becomes the new password. If you want to keep the same password as before, enter the same password.

- 7 Press ENTER.**

 moves to [EXIT]. Pressing ENTER again returns to the [OTHERS] menu of the preference display.

NOTE

If you enter the wrong password more than 3 times in step 3 above,  moves to [EXIT] automatically and ▲/▼ do not work.

To temporarily release the Parental Lock



If the parental level is set to a strict value, some discs may not play at all.

When you insert such a disc and try to play it, the following parental lock on-screen display appears on the TV screen, asking you whether you want the parental lock to be temporarily released or not.

- 1 Press ▲/▼ to move  to [TEMPORARY RELEASE], then press ENTER.**

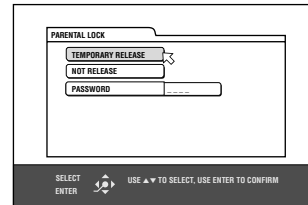

- 2 Press the numeric buttons (0 to 9) to enter your 4-digit password.**

The Parental Lock is released, and the player starts playback. If you enter a wrong password, "WRONG! RETRY..." appears on the TV screen. Enter the correct password.

NOTE

When you enter the wrong password 3 times at step 2 above,  moves to [NOT RELEASE] automatically and ▲/▼ do not work.

Additional information

AV COMPU LINK remote control system

The JVC AV COMPU LINK system allows you to enjoy video or audio with the simplest operation. If your video/audio player (such as a DVD player, CD player and VCR) and television or/and amplifier/receiver support the JVC AV COMPU LINK system and are tied with the JVC AV COMPU LINK cable(s), simply starting the player will automatically make all necessary settings on the television and/or amplifier/receiver to allow you to enjoy the playback.

AV COMPU LINK

Connection and setup

Using an AV COMPU LINK cable, connect the AV COMPU LINK terminals of each component to one another.

- The player's AV COMPU LINK setting is controlled using the OTHERS menu in the preference display. See page 30.
- For information on the connection between a TV and a receiver, refer to the receiver's instructions.

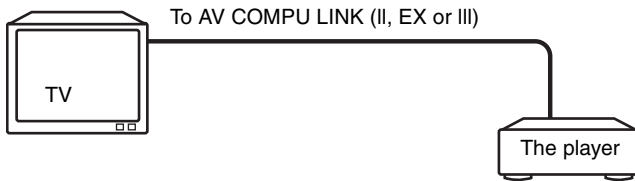

- If you connect the player to a television via AV COMPU LINK, set the player's AV COMPU LINK setting as follows.
 - When connecting to the VIDEO-1 input terminal of the television: DVD2
 - When connecting to the VIDEO-2 input terminal of the television: DVD3

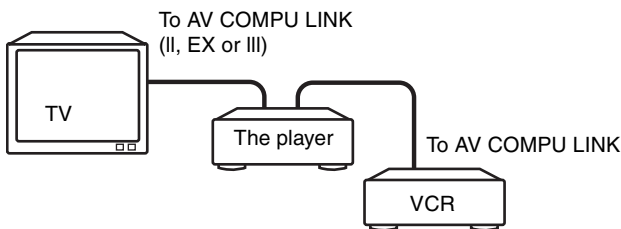

- If you connect the player to a television and VCR via AV COMPU LINK, set the VCR's Remote Control Code and the player's AV COMPU LINK setting as follows.
 - When connecting to the VIDEO-1 input terminal of the television:
The player's AV COMPU LINK setting: DVD2
VCR's Remote Control Code: B
 - When connecting to the VIDEO-2 input terminal of the television:
The player's AV COMPU LINK setting: DVD3
VCR's Remote Control Code: A

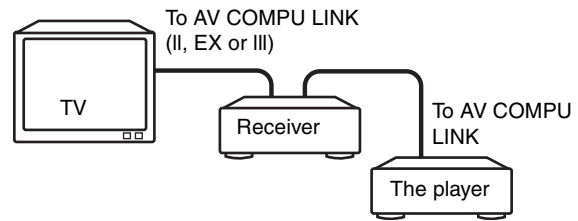

- If you connect the player to a television and receiver via AV COMPU LINK, set the player's AV COMPU LINK setting to DVD1.

IMPORTANT!

When you make video connection between the player and another device (such as a receiver and TV) via the composite, S-video or component jacks, as well as AV COMPU LINK connection, see also the instruction manual of the other device.

Notes for connection

- If you connect the player to a receiver via AV COMPU LINK in a system including a Dolby Digital decoder, some functions may not be performed automatically.
- Connect the AUDIO OUT jacks of the player to the audio input jacks of a receiver indicating "DVD." Otherwise, the system will not work correctly.
- There may be no description about connections to the player in the instruction manual of a television or VCR. However, a television or VCR with AV COMPU LINK terminals indicating "II," "EX" or "III" can be connected to the player.

Operation

The JVC AV COMPU LINK system allows you to enjoy video and/or audio by simply pressing Play on the source component (the component which plays back the video or audio, such as a DVD player or VCR). You do not even have to switch on power on the TV or receiver.

- 1 Turn on the main power of the television.**
- 2 Insert a disc (or tape) into the source component.**
- 3 Press ► of the source component.**

The following actions are performed automatically:

- Turning on the television power.
- Setting the source of the television to the external input (VIDEO-1 or VIDEO-2).
- Turning on receiver power.
- Setting the source of the receiver to the component which has started playback.

Troubleshooting

Power

Power does not come on.

- ➔ Power plug is not inserted securely. Plug in securely.

Operation

“REGION CODE ERROR!” is shown on the TV screen.

- ➔ Region code of the inserted disc does not match the player.
Check the region code of the disc printed on the disc jacket.

Operation is not possible.

- ➔ Microcomputer malfunction due to lightning or static electricity.
Turn off the power and unplug the power cord, then connect the power cord again.
- ➔ Moisture condensation caused by a sudden change of temperature or humidity. Turn off the power, then turn it on a few hours later.
- ➔ The disc does not allow the operation, or an unplayable disc is inserted. Check and replace the disc (see page 2).

[TRAY LOCK] is displayed on the display window and the disc tray does not open.

- ➔ When you press ▲ while pressing down ■ on the player in standby mode, the tray lock function is activated. The disc tray cannot be opened or closed in this status. To release this status, press ▲ while pressing down ■ on the player in standby mode. ([LOCK OFF] is displayed on the display window.)

Picture

Picture is noisy.

- ➔ The player is connected to a VCR directly and the copyguard function is activated. Connect the player so that the picture signal flows directly to the TV.
- ➔ With some discs, the picture may be blurred when [PICTURE SOURCE] is set to [FILM] or [AUTO]. Set [PICTURE SOURCE] to [VIDEO(NORMAL)] or [VIDEO(ACTIVE)].

Correct picture cannot be obtained.

- ➔ Connect only one type of cable to the jack(s) you want to use on this player, either the VIDEO jack, S-VIDEO jack or COMPONENT VIDEO OUT jacks. (Note that you can connect cables to the VIDEO jack and COMPONENT VIDEO OUT jacks at the same time.) If an S-VIDEO cable is connected to the S-VIDEO jack, the player is set to the S-VIDEO output mode automatically.

No picture is displayed on the TV screen, or the picture is blurred or divided in two parts.

- ➔ The player is in the progressive scanning mode while the PAL/NTSC selector is set to “PAL.” Set the 525i/625i - 525p/625p - REMOTE selector on the rear panel to “525p/625p,” or set it to “REMOTE” and make the Progressive scanning mode inactive by using the VFP - PROGRESSIVE SCAN button (see page 6).

Audio

DVD VIDEO disc playback sound level is lower than TV broadcast sound level.

- ➔ Set the [D.RANGE CONTROL] preference to [TV MODE] (see page 30).

Analog audio output is distorted.

- ➔ Set the [OUTPUT LEVEL] preference to [LOW] (see page 30).

MP3/WMA/JPEG/MPEG-4/DivX

No sound and/or no picture comes out.

- ➔ MP3/WMA/MPEG-4 disc is recorded with the “packet writing (UDF format).” It cannot be played.
- ➔ Check the files you want to play back.

Files (tracks) are not played in the recorded order.

- ➔ This player plays the files in the alphabetic order. So, the playback order can vary.

WMA files cannot be played back.

- ➔ The file is copy protected.
- ➔ The file is recorded with a bit rate under 48 kbps. The player does not support such WMA files.

MPEG-4 files cannot be played back.

- ➔ The format of the file is not asf.

DivX files are played back without sound.

- ➔ This player can play back the MP3 sound for the audio part of the DivX files. Select the proper audio CODEC when making DivX files.

Specifications

Specifications and appearance are subject to change without prior notice.

General

Readable discs	DVD VIDEO, DVD-R (Video format), DVD-RW (Video format), SVCD, Video CD, Audio CD (CD-DA), CD-R/RW (CD-DA, SVCD, Video CD, MP3/WMA format, JPEG, MPEG-4 (Advanced simple profile/Simple profile), DivX)
Readable cards	SD card, MultiMediaCard, Smart Media, CompactFlash, Memory Stick, xD-Picture card (MP3/WMA format, JPEG, MPEG-4 (Simple Profile))
Video format	REMOTE, 525i/625i (Interlaced scan)/525p/625p (Progressive scan) selectable

Other

Power requirements	AC 110 V - 240 V \sim , 50 Hz/60 Hz (Only for the Australia model: AC 240 V \sim , 50 Hz)
Power consumption	10 W (POWER ON), 1.1 W (STANDBY mode)
Mass	2.1 kg
Dimensions (W × H × D)	435 mm × 47 mm × 259 mm

Video outputs

COMPONENT (pin jacks)	Y Output: 1.0 Vp-p (75 Ω) P _B /P _R Output: 0.7 Vp-p (75 Ω)
VIDEO OUT (pin jack)	1.0 Vp-p (75 Ω)
S-VIDEO OUT (S jack)	Y Output: 1.0 Vp-p (75 Ω) C Output: 286 mVp-p (75 Ω)
Horizontal resolution	500 lines or more

Audio outputs

ANALOG OUT (pin jack)	2.0 Vrms (10 kΩ)
DIGITAL OUT (COAXIAL)	0.5 Vp-p (75 Ω termination)
DIGITAL OUT (OPTICAL)	-21 dBm to -15 dBm (peak)

Audio characteristics

Frequency response	CD (sampling frequency 44.1 kHz): 2 Hz to 20 kHz DVD (sampling frequency 48 kHz): 2 Hz to 22 kHz (4 Hz to 20 kHz for DTS and Dolby Digital bitstream signals) DVD (sampling frequency 96 kHz): 2 Hz to 44 kHz
Dynamic range	16 bit: More than 98 dB 20 bit/24 bit: More than 100 dB
Wow and flutter	Unmeasurable (less than ± 0.002%)
Total harmonic distortion	less than 0.007%

- Manufactured under license from Dolby Laboratories. “Dolby” and the double-D symbol are trademarks of Dolby Laboratories.
- “DTS” and “DTS 2.0+ Digital Out” are trademarks of Digital Theater Systems, Inc.
- USE OF THIS PRODUCT IN ANY MANNER THAT COMPLIES WITH THE MPEG-4 VISUAL STANDARD IS PROHIBITED, EXCEPT FOR USE BY A CONSUMER ENGAGING IN PERSONAL AND NON-COMMERCIAL ACTIVITIES.
- “Official DivX Certified™ product”
“Plays DivX® 5, DivX® 4, DivX® 3, and DivX® VOD video content (in compliance with DivX Certified™ technical requirements)”
“DivX, DivX Certified, and associated logos are trademarks of DivXNetworks, Inc. and are used under license.”
- This product incorporates copyright protection technology that is protected by U.S. patents and other intellectual property rights. Use of this copyright protection technology must be authorized by Macrovision Corporation, and is intended for home and other limited viewing uses only unless otherwise authorized by Macrovision. Reverse engineering or disassembly is prohibited.
- “CONSUMERS SHOULD NOTE THAT NOT ALL HIGH DEFINITION TELEVISION SETS ARE FULLY COMPATIBLE WITH THIS PRODUCT AND MAY CAUSE ARTIFACTS TO BE DISPLAYED IN THE PICTURE. IN CASE OF 525 OR 625 PROGRESSIVE SCAN PICTURE PROBLEMS, IT IS RECOMMENDED THAT THE USER SWITCH THE CONNECTION TO THE ‘STANDARD DEFINITION’ OUTPUT. IF THERE ARE QUESTIONS REGARDING OUR TV SET COMPATIBILITY WITH THIS MODEL 525p AND 625p DVD PLAYER, PLEASE CONTACT OUR CUSTOMER SERVICE CENTER.”

Appendix A: Digital output signal chart

(for page 30)

Source type	Output		
	PCM ONLY	DOLBY DIGITAL/PCM	STREAM/PCM
DVD with 48 kHz, 16/20/24 bit linear PCM	48 kHz, 16 bit, stereo linear PCM		
DVD with 96 kHz, 16/22/24 bit linear PCM			
DVD with DTS	48 kHz, 16 bit, stereo linear PCM	DTS bitstream	
DVD with Dolby Digital	48 kHz, 16 bit, stereo linear PCM	Dolby Digital bitstream	
DVD with MPEG Multichannel	48 kHz, 16 bit, stereo linear PCM	MPEG bitstream	
SVCD/Video CD/Audio CD	44.1 kHz, 16 bit, stereo linear PCM		
Audio CD with DTS	48 kHz, 16 bit, stereo linear PCM	DTS bitstream	
CD-R/RW or memory card recorded MP3/WMA, CD-R/RW or DVD-R/-RW recorded DivX	Linear PCM		
CD-R/RW or memory card recorded MPEG-4	Cannot be outputted		

Appendix B: Country/Area code list for Parental Lock

(for page 31)

AD	Andorra	ER	Eritrea	LA	Lao People's Democratic Republic	RW	Rwanda
AE	United Arab Emirates	ES	Spain	LB	Lebanon	SA	Saudi Arabia
AF	Afghanistan	ET	Ethiopia	LC	Saint Lucia	SB	Solomon Islands
AG	Antigua and Barbuda	FI	Finland	LI	Liechtenstein	SC	Seychelles
AI	Anguilla	FJ	Fiji	LK	Sri Lanka	SD	Sudan
AL	Albania	FK	Falkland Islands	LR	Liberia	SE	Sweden
AM	Armenia	FM	Micronesia (Federated States of)	LS	Lesotho	SG	Singapore
AN	Netherlands Antilles	FO	Faroe Islands	LT	Lithuania	SH	Saint Helena
AO	Angola	FR	France	LU	Luxembourg	SI	Slovenia
AQ	Antarctica	FX	France, Metropolitan	LV	Latvia	SJ	Svalbard and Jan Mayen
AR	Argentina	GA	Gabon	LY	Libyan Arab Jamahiriya	SK	Slovakia
AS	American Samoa	GB	United Kingdom	MA	Morocco	SL	Sierra Leone
AT	Austria	GD	Grenada	MC	Monaco	SM	San Marino
AU	Australia	GE	Georgia	MD	Moldova, Republic of	SN	Senegal
AW	Aruba	GF	French Guiana	MG	Madagascar	SO	Somalia
AZ	Azerbaijan	GH	Ghana	MH	Marshall Islands	SR	Suriname
BA	Bosnia and Herzegovina	GI	Gibraltar	ML	Mali	ST	Sao Tome and Principe
BB	Barbados	GL	Greenland	MM	Myanmar	SV	El Salvador
BD	Bangladesh	GM	Gambia	MN	Mongolia	SY	Syrian Arab Republic
BE	Belgium	GN	Guinea	MO	Macao	SZ	Swaziland
BF	Burkina Faso	GP	Guadeloupe	MP	Northern Mariana Islands	TC	Turks and Caicos Islands
BG	Bulgaria	GQ	Equatorial Guinea	MQ	Martinique	TD	Chad
BH	Bahrain	GR	Greece	MR	Mauritania	TF	French Southern Territories
BI	Burundi	GS	South Georgia and the South Sandwich	MS	Montserrat	TG	Togo
BJ	Benin	GT	Guatemala	MT	Malta	TH	Thailand
BM	Bermuda	GU	Guam	MU	Mauritius	TJ	Tajikistan
BN	Brunei Darussalam	GU	Guam	MV	Maldives	TK	Tokelau
BO	Bolivia	GW	Guinea-Bissau	MW	Malawi	TM	Turkmenistan
BR	Brazil	GY	Guyana	MX	Mexico	TN	Tunisia
BS	Bahamas	HK	Hong Kong	MY	Malaysia	TO	Tonga
BT	Bhutan	HM	Heard Island and McDonald Islands	NZ	Mozambique	TP	East Timor
BV	Bouvet Island	HN	Honduras	NA	Namibia	TR	Turkey
BW	Botswana	HR	Croatia	NC	New Caledonia	TT	Trinidad and Tobago
BY	Belarus	HT	Haiti	NE	Niger	TV	Tuvalu
BZ	Belize	HU	Hungary	NF	Norfolk Island	TW	Taiwan
CA	Canada	ID	Indonesia	NG	Nigeria	TZ	Tanzania, United Republic of
CC	Cocos (Keeling) Islands	IE	Ireland	NI	Nicaragua	UA	Ukraine
CF	Central African Republic	IL	Israel	NL	Netherlands	UG	Uganda
CG	Congo	IN	India	NO	Norway	UM	United States Minor Outlying Islands
CH	Switzerland	IO	British Indian Ocean Territory	NP	Nepal	US	United States
CI	Côte d'Ivoire	IQ	Iraq	NR	Nauru	UY	Uruguay
CK	Cook Islands	IR	Iran (Islamic Republic of)	NU	Niue	UZ	Uzbekistan
CL	Chile	IS	Iceland	NZ	New Zealand	VA	Vatican City State (Holy See)
CM	Cameroon	IT	Italy	OM	Oman	VC	Saint Vincent and the Grenadines
CN	China	JM	Jamaica	PA	Panama	VE	Venezuela
CO	Colombia	JO	Jordan	PE	Peru	VG	Virgin Islands (British)
CR	Costa Rica	JP	Japan	PF	French Polynesia	VI	Virgin Islands (U.S.)
CU	Cuba	KE	Kenya	PG	Papua New Guinea	VN	Vietnam
CV	Cape Verde	KG	Kyrgyzstan	PH	Philippines	VU	Vanuatu
CX	Christmas Island	KH	Cambodia	PK	Pakistan	WF	Wallis and Futuna Islands
CY	Cyprus	KI	Kiribati	PL	Poland	WS	Samoa
CZ	Czech Republic	KM	Comoros	PM	Saint Pierre and Miquelon	YE	Yemen
DE	Germany	KN	Saint Kitts and Nevis	PN	Pitcairn	YT	Mayotte
DJ	Djibouti	KP	Korea, Democratic People's Republic of	PR	Puerto Rico	YU	Yugoslavia
DK	Denmark	KR	Korea, Republic of	PT	Portugal	ZA	South Africa
DM	Dominica	KW	Kuwait	PW	Palau	ZM	Zambia
DO	Dominican Republic	KY	Cayman Islands	PY	Paraguay	ZR	Zaire
DZ	Algeria	KZ	Kazakhstan	QA	Qatar	ZW	Zimbabwe
EC	Ecuador			RE	Réunion		
EE	Estonia			RO	Romania		
EG	Egypt			RU	Russian Federation		
EH	Western Sahara						

Appendix C: Table of languages and their abbreviations

(for pages 19 and 29)

AA	Afar	FA	Persian	KM	Cambodian	OM	(Afan) Oromo	SU	Sundanese
AB	Abkhazian	FI	Finnish	KN	Kannada	OR	Oriya	SV	Swedish
AF	Afrikaans	FJ	Fiji	KO	Korean (KOR)	PA	Panjabi	SW	Swahili
AM	Ameharic	FO	Faroese	KS	Kashmiri	PL	Polish	TA	Tamil
AR	Arabic	FY	Frisian	KU	Kurdish	PS	Pashto, Pushto	TE	Telugu
AS	Assamese	GA	Irish	KY	Kirghiz	PT	Portuguese	TG	Tajik
AY	Aymara	GD	Scots Gaelic	LA	Latin	QU	Quechua	TH	Thai
AZ	Azerbaijani	GL	Galician	LN	Lingala	RM	Rhaeto-Romance	TI	Tigrinya
BA	Bashkir	GN	Guarani	LO	Laotian	RN	Kirundi	TK	Turkmen
BE	Byelorussian	GU	Gujarati	LT	Lithuanian	RO	Rumanian	TL	Tagalog
BG	Bulgarian	HA	Hausa	LV	Latvian, Lettish	RU	Russian	TN	Setswana
BH	Bihari	HI	Hindi	MG	Malagasy	RW	Kinyarwanda	TO	Tongan
BI	Bislama	HR	Croatian	MI	Maori	SA	Sanskrit	TR	Turkish
BN	Bengali, Bangla	HU	Hungarian	MK	Macedonian	SD	Sindhi	TS	Tsonga
BO	Tibetan	HY	Armenian	ML	Malayalam	SG	Sangho	TT	Tatar
BR	Breton	IA	Interlingua	MN	Mongolian	SH	Serbo-Croatian	TW	Twi
CA	Catalan	IE	Interlingue	MO	Moldavian	SI	Singhalese	UK	Ukrainian
CO	Corsican	IK	Inupiak	MR	Marathi	SK	Slovak	UR	Urdu
CS	Czech	IN	Indonesian	MS	Malay (MAY)	SL	Slovenian	UZ	Uzbek
CY	Welsh	IS	Icelandic	MT	Maltese	SM	Samoa	VI	Vietnamese
DA	Danish	IW	Hebrew	MY	Burmese	SN	Shona	VO	Volapuk
DZ	Bhutani	JI	Yiddish	NA	Nauru	SO	Somali	WO	Wolof
EL	Greek	JW	Javanese	NE	Nepali	SQ	Albanian	XH	Xhosa
EO	Esperanto	KA	Georgian	NL	Dutch	SR	Serbian	YO	Yoruba
ET	Estonian	KK	Kazakh	NO	Norwegian	SS	Siswati	ZU	Zulu
EU	Basque	KL	Greenlandic	OC	Occitan	ST	Sesotho		

Appendix D: Glossary

525i/625i/525p/625p

Indicates the number of scanning lines and scanning format of an image signal. 525i (625i) indicates 525 (625) scanning lines with interlace format, and 525p (625p) indicates 525 (625) scanning lines with progressive format.

ASF

ASF is an abbreviation of "Advanced Streaming Format," and is a data compression format for streaming developed by Microsoft Corporation. ASF can contain the various data types such as audio, video, and text.

Aspect ratio

A ratio which defines the shape of the rectangular picture in a TV. It is the width of the picture relative to the height. A conventional TV picture is 4:3 in aspect ratio.

Bitstream

The digital form of multichannel audio data (e.g., 5.1-channel) before it is decoded into its various channels.

Chapter/title

Chapter is the smallest division and title is the largest division on DVD VIDEO. A chapter is a division of a title and similar to a track for Video CD or Audio CD.

Component video

Video signals with three channels of separate information that makes up the picture. There are some types of component video, such as R/G/B and Y/C_B(P_B)/C_R(P_R).

Composite video

A single video signal commonly used in most consumer video products that contains all luminance, color, and synchronization information.

DivX

One of the encoding methods for making MPEG-4 files.

Dolby Digital (AC3)

A six-channel system consisting of left, center, right, left rear, right rear and LFE (Low-Frequency Effect channel, for use with a sub-woofer) channels. All processing is done in the digital domain. Not all Dolby Digital discs contain six (5.1) channels of information.

Dolby Surround/Dolby Pro Logic

Dolby Surround records four channels of front and rear audio in two channels in a way that allows a decoder to recover the original four channels for playback. Because the audio is recorded in two channels, it can be played back naturally by a two-channel stereo system.

Dolby Pro Logic introduces directional circuits in decoder-side processing (increasing the level of specific channels and lowering the level of silent channels) for greater spatial perspective, and adds a center speaker used primarily for dialog. The result is enhanced channel separation.

Down-mix

Internal stereo mix of multichannel surround audio by a DVD player. The down-mix signals are output from stereo output connectors.

DTS

A Digital Surround audio encoding format configured with six (5.1) channels, similar to Dolby Digital. It requires a decoder, either in the player or in an external receiver. DTS stands for Digital Theater Systems.

Not all DTS discs contain six (5.1) channels of information.

Dynamic range

The difference between the loudest and softest sounds.

Interlaced scanning

In a conventional video system, a picture is shown on the display monitor in between lines of two halves. The Interlaced scanning system places lines of the second half of the picture in-between lines of the first half of the picture.

JPEG

A popular file format for still image compression and storage. JPEG stands for Joint Photographic Experts Group.

There are three sub-types of the JPEG format as follows.

- baseline JPEG: used for digital cameras, the web, etc.
- progressive JPEG: used for the web
- lossless JPEG: an old type, rarely used now

Linear PCM audio

PCM stands for "pulse code modulation." Linear PCM is the usual method for digitally encoding audio without compression, and is used for the audio tracks on DVD VIDEO discs, Audio CDs, etc.

MP3

MP3 is an audio data compression format, which stands for MPEG-1 Audio Layer 3. Using MP3, you can achieve a data reduction of about 1:10.

MPEG-4

MPEG-4 is an audio/video data compression format, which is highly efficient and more stable than MPEG-1 and MPEG-2.

NTSC (National television system committee)

A black and white and color television system format used in the U.S.A., Canada, Mexico and Japan.

PAL (Phase Alternation by Line)

A color television system format used extensively in Western Europe.

PBC

PBC stands for "Playback control" and is a method of controlling disc play for Video CDs (VCD). You are able to interact with the disc through menus.

Progressive scanning

Progressive scanning displays all the horizontal lines of a picture at one time, as a single frame. A progressive scanning DVD player converts the interlaced (525i/625i) video from DVD into progressive (525p/625p) format for connection to a progressive display. It dramatically increases the vertical resolution.

S-video

A video signal which improves picture quality over standard composite connections. Used on Super VHS, DVD, high end TV monitors, etc.

Track

The smallest division on SVCD, Video CD and Audio CD discs.

WMA

WMA is an abbreviation of "Windows Media Audio," and is an audio data compression format developed by Microsoft Corporation. Sound quality of data compressed using WMA is the same as that of MP3, though the WMA file size is smaller than that of MP3.

XV-NP10S

DVD PLAYER/MEMORY CARD READER

